



# SUMMIT SERIES SHEDS

**BUILDING SHELL INSTALLATION GUIDE**

v6 - September 1, 2022

|                  |                               |
|------------------|-------------------------------|
| <b>CHAPTER 1</b> | <b>FOUNDATION PREPARATION</b> |
| <b>CHAPTER 2</b> | <b>WALLS</b>                  |
| <b>CHAPTER 3</b> | <b>ROOF</b>                   |
| <b>CHAPTER 4</b> | <b>DOOR</b>                   |

**REQUIRED DOCUMENTS:**

-  Reference project installation drawings
-  Reference permit plan set for additional details

**RECOMMENDED TOOLS:**

- |  |   |
|--|---|
| <input type="checkbox"/> DRILL DRIVER                                  | <input type="checkbox"/> COMPRESSOR   |
| <input type="checkbox"/> WOOD DRILL BIT SET                            | <input type="checkbox"/> 10 oz CAULK GUN  |
| <input type="checkbox"/> 3/4" PADDLE BIT                               | <input type="checkbox"/> UTILITY KNIFE  |
| <input type="checkbox"/> IMPACT DRIVER                                 | <input type="checkbox"/> HAMMER DRILL (CONCRETE SLABS ONLY)   |
| <input type="checkbox"/> 1/4" NUT DRIVER BIT                           | <input type="checkbox"/> 1/2" MASONRY BIT   |
| <input type="checkbox"/> #2 PHILLIPS BIT                               | <input type="checkbox"/> 3/4" MASONRY BIT MAY BE REQUIRED, SEE PERMIT PLAN SET  |
| <input type="checkbox"/> #3 PHILLIPS BIT                               | <input type="checkbox"/> COMPOUND MITER SAW   |
| <input type="checkbox"/> T25 TORQUE BIT                                | <input type="checkbox"/> GENERAL CARPENTRY TOOLS<br>(6-ft LEVEL, TIN SNIPS, HAMMER, MEASURING TAPE, CHALK LINES, PENCILS, SQUARE, ETC.) |
| <input type="checkbox"/> T30 TORQUE BIT                                | <input type="checkbox"/> 6-FT LADDER MINIMUM  |
| <input type="checkbox"/> 3/8" CROWN STAPLER                            |   |
| <input type="checkbox"/> T-50 ROOF STAPLES, SEE PROVIDED SHOPPING LIST |   |
| <input type="checkbox"/> PNEUMATIC FRAMING NAILER                      |   |
| <input type="checkbox"/> 3" 16d NAILS, SEE PROVIDED SHOPPING LIST      |   |
| <input type="checkbox"/> 2 3/8" 8d NAILS, SEE PROVIDED SHOPPING LIST   |   |
| <input type="checkbox"/> OSCILATING MULTI TOOL                         |   |

**\*\* IMPORTANT \*\***

**SAFETY IS YOUR #1 RESPONSIBILITY. ALWAYS WEAR TASK APPROPRIATE PERSONAL PROTECTIVE EQUIPMENT (PPE) SUCH AS OSHA-APPROVED GLASSES, GLOVES, WORK BOOTS, ETC.**

**MAKE SURE YOU HAVE ALL THE SUPPLEMENTAL MATERIALS FROM YOUR SPECIFIC SHOPPING LIST**

**\*CONTACT [InstallationSupport@studioshed.com](mailto:InstallationSupport@studioshed.com) FOR QUESTIONS\***

**FLOOR PREP:**

*Fig 2a:*

- Floor should be built to the exact dimensions of the shed and should be square and level.

**\*We recommend using a laser level to accurately determine if the foundation is level. Take your time to be precise, it will save time later!\***

- \* If the shed foundation is larger than the shed:
- Snap reference lines outlining the perimeter dimensions of the shed
- ensure lines are parallel and square
- If you intend to use an existing foundation, especially one that is not the exact size of your shed, consult with Studio Shed as this may impact total cost and warranty.
- Top of foundation should be minimum 8" above adjacent grade

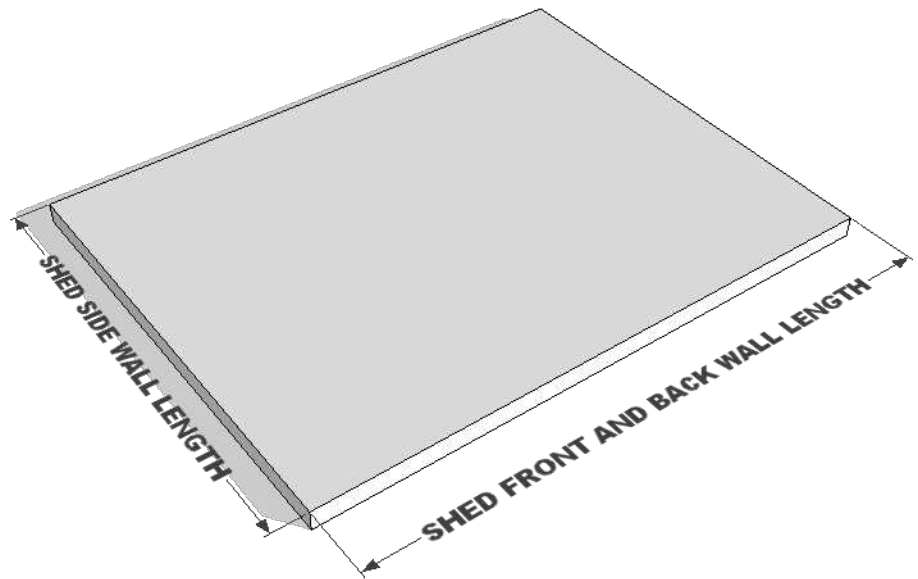

**SILL PREP:**

*Fig 2b:*

- Mark sill plate reference lines using chalk line and tape measure

- snap lines 6" in from edge / perimeter of the shed on all sides

\*sill plates will have a 1/2" inset from the edge

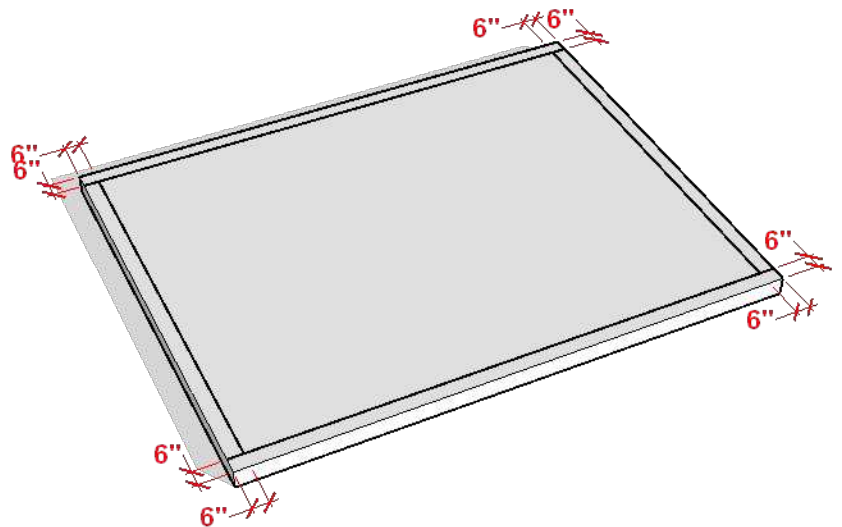

**CHECK FOUNDATION FOR SQUARE:**

- Use a tape measure to check for square by measuring from opposite inside corners of the sill plate reference lines
- The measurements should be equal
- If unequal, make ay adjustments to make sure edge distance and squareness are correct.

*Fig 3a:*

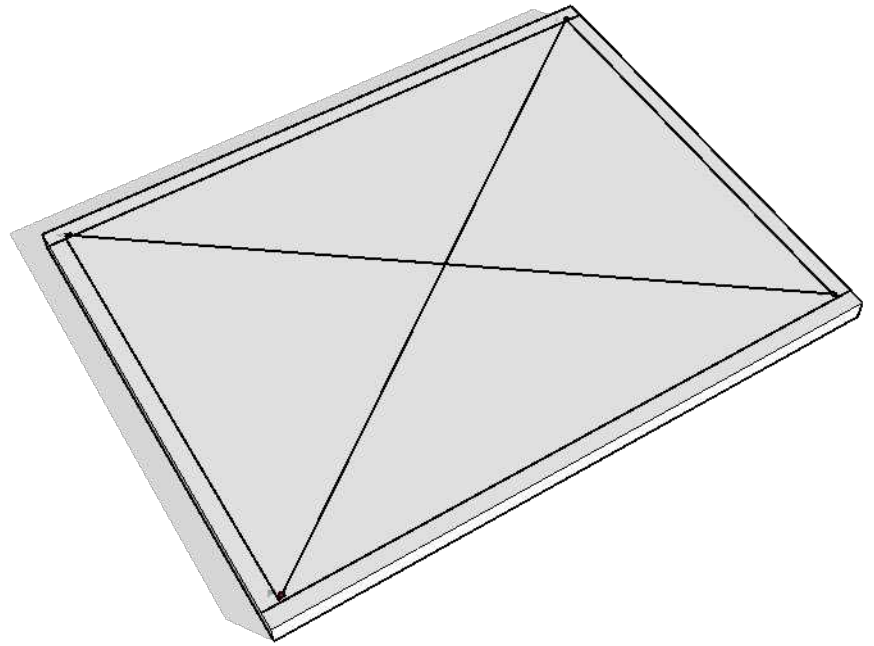

**APPLY SILL FOAM GASKET:**

- Apply sill foam gasket around perimeter using one of the following methods:
- **(A)** Use sill plate reference lines as a guide and lay gasket on foundation
- **(B)** Staple sill seal to the bottom of the of the sill plates (prior to installation).  
\*easier/more precise\*

*Fig 3b:*

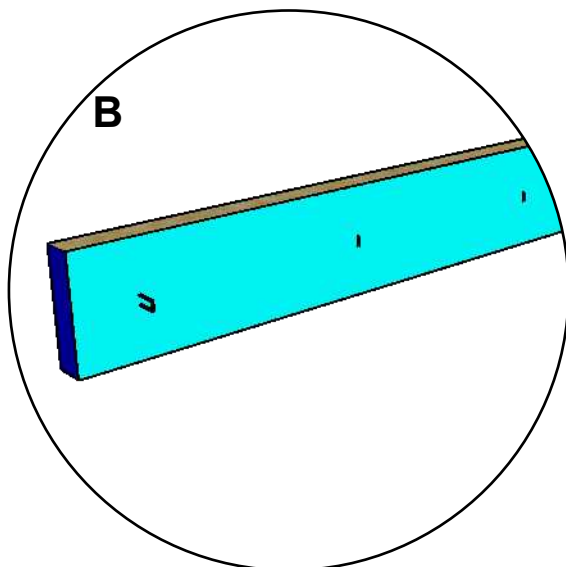
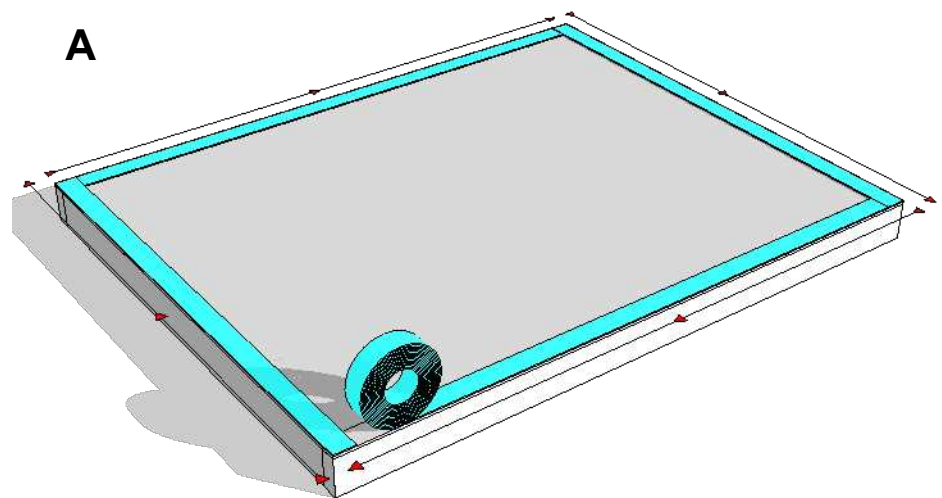

**LOOSE FIT 2x6 TREATED LSL SILL PLATES:**

*Fig 4a:*

**\*Ends of treated LSL sill plates will be painted blue (color may vary) - verify LSL material.**

- Align inside edge of the sill plates with the reference lines, the sill plates will sit in-set 1/2" from the edge of the floor/perimeter of the shed.

- **DO NOT** fasten to floor with anchors just yet, although you may tack the sill plate down with nails/pins

\*front and back wall plates run full length

Side wall sill plates sit within front and back wall sill plates

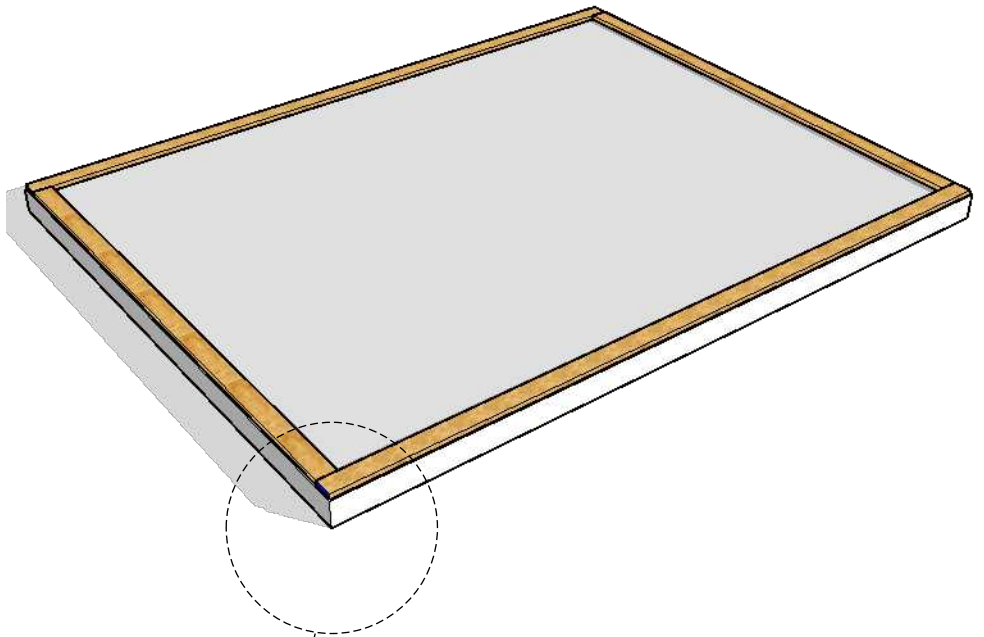

Reference project installation drawings for sill plate lengths.

*Fig 4b:*

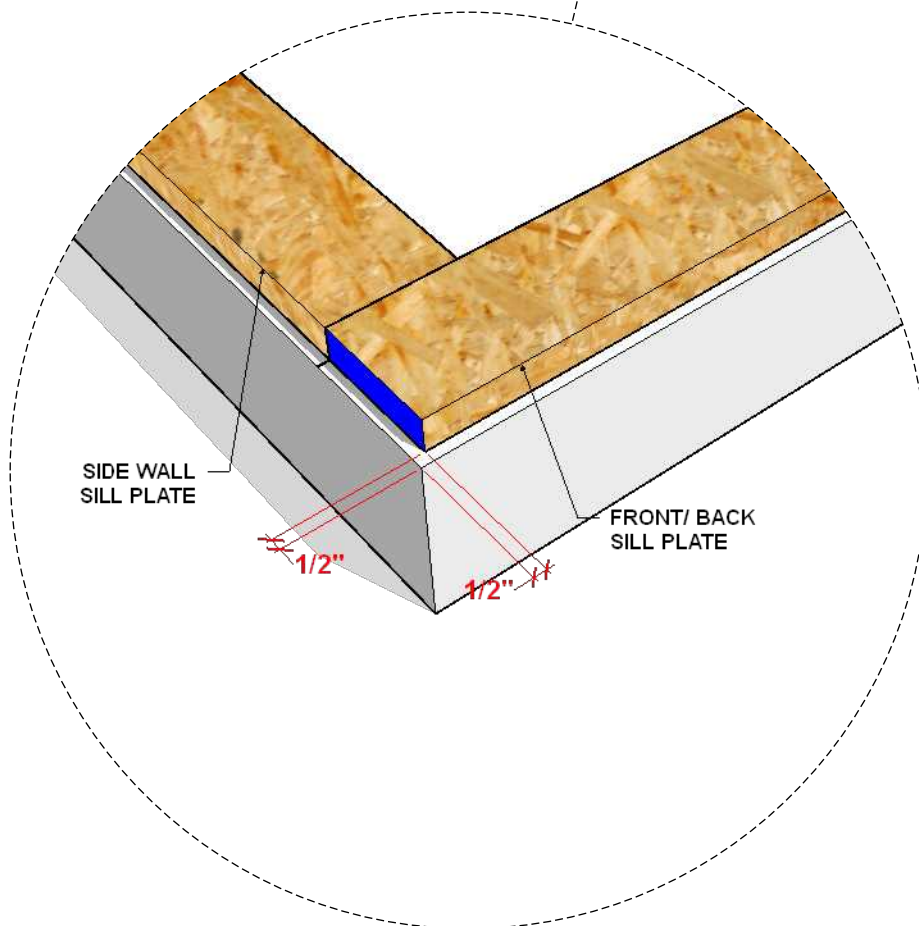

**PREP WALLS FOR INSTALLATION:**

*Fig 5a:*

- Using a T25 torxbit, remove all shipping blocks from around operable windows and from the base of the wall panels.
- Use supplied zip tape to cover any screw holes from attaching the shipping blocks. **DO NOT apply zip tape to bottom flange of window as this may trap water.**
- \*HANDLE PANELS WITH CARE! DO NOT REST DIRECTLY ON GROUND! REMOVING SHIPPING BLOCKS WILL LEAVE EXPOSED 1 1/2" OF EXPOSED SHEATHING AT TOP AND BOTTOM OF PANEL. SOME PANELS WILL HAVE 6" OVERHANGS AT SIDES.\***

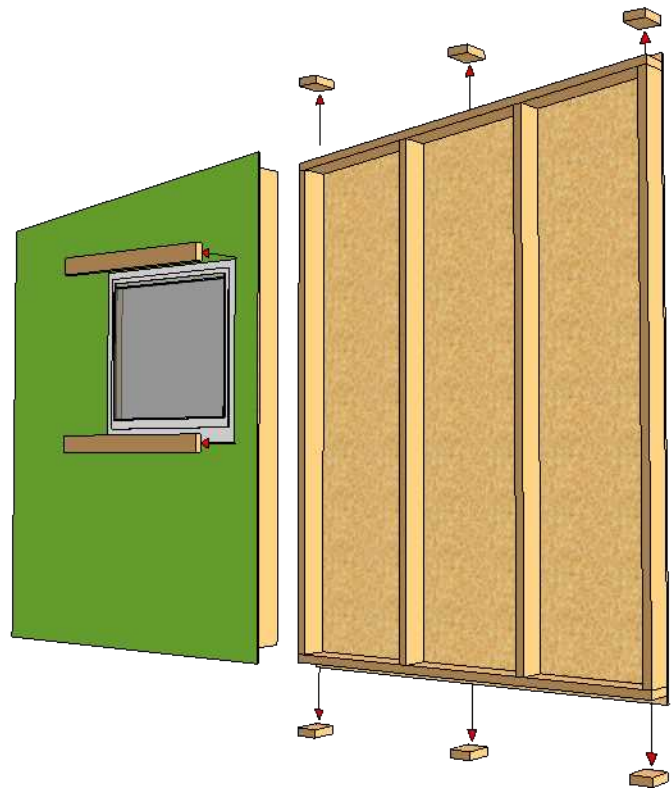

**STAND AND LOOSE-FIT WALL PANELS:**

*Fig 5b:*

- Ensure the floor/sill is level
- If not, start at higher back corner and use shims under wall panels to ensure alignment.
- Starting at a back wall corner, stand a back panel and an adjacent rake wall (side wall) panel. Loose fit panels to allow for a needed adjustments

**\*Side walls will overlap front and back sill plates**

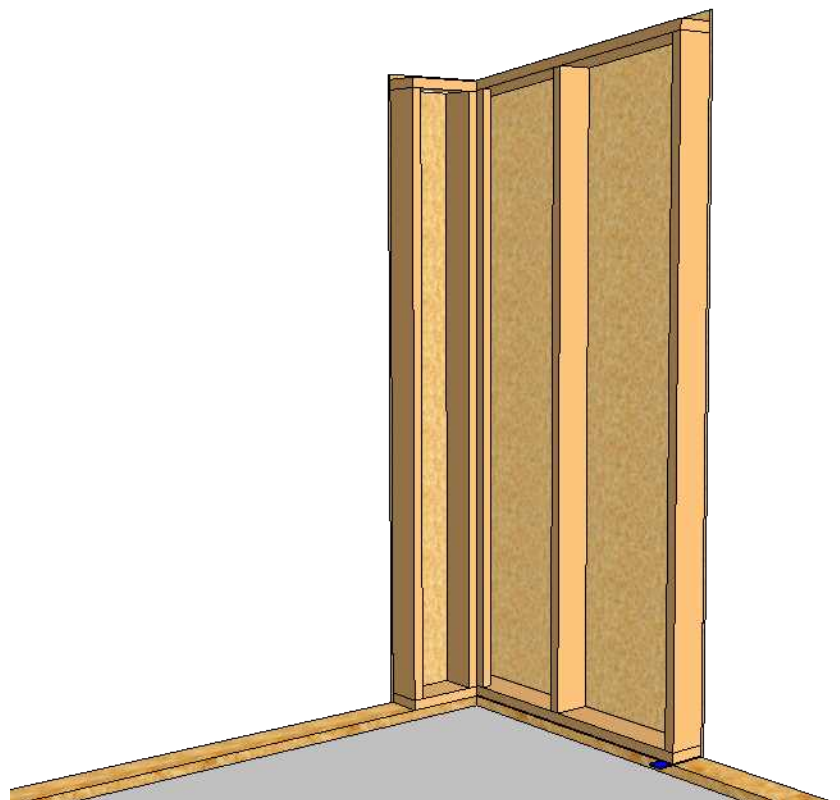

Reference project installation drawings cover sheet for panel layout, SKU numbers will be written on wall panels

**PANEL ALIGNMENT WITH FLOOR:**

- Front and back wall sheathing should be flush with face of floor/perimeter line of shed.
- Some side walls will have double studs. California corners or Drywall clips should be added as needed in field. See shopping list.

**\*STUD LAYOUT MAY VARY\***

*Fig 6a:*

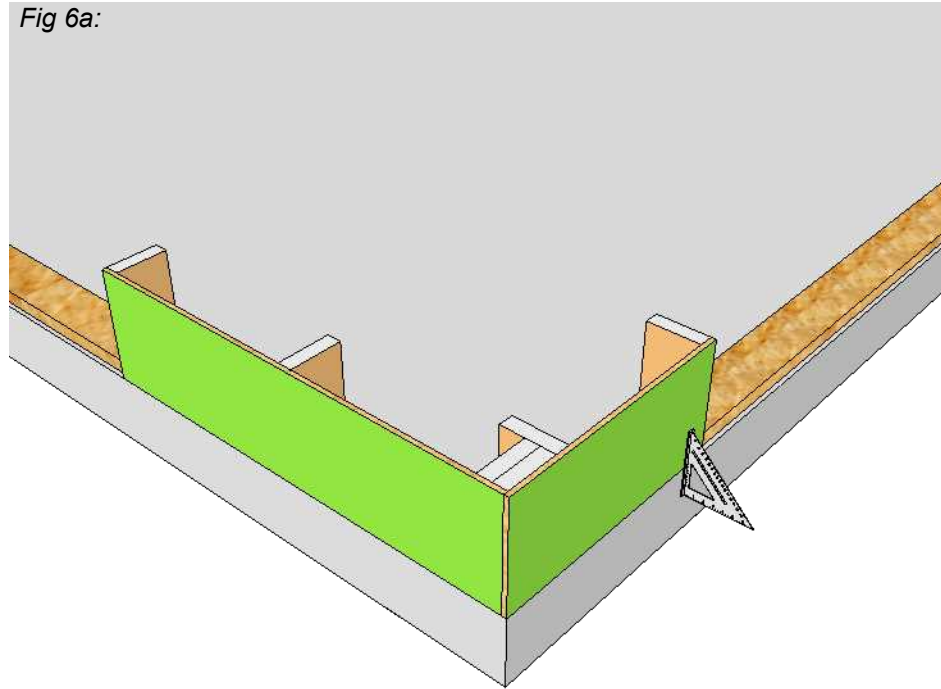

**CHECK PANELS FOR LEVEL AND PLUMB:**

- Using a carpenter's level, ensure panels are level and plumb prior to installing fasteners.
- If needed, shim by placing shim in-between pressure treated sill and bottom wall panel.

**\*Top plates should be flush, back wall top plate should have a bevel.**

**\*TAKE YOUR TIME, ACCURACY IS IMPORTANT!\***

*Fig 6b:*

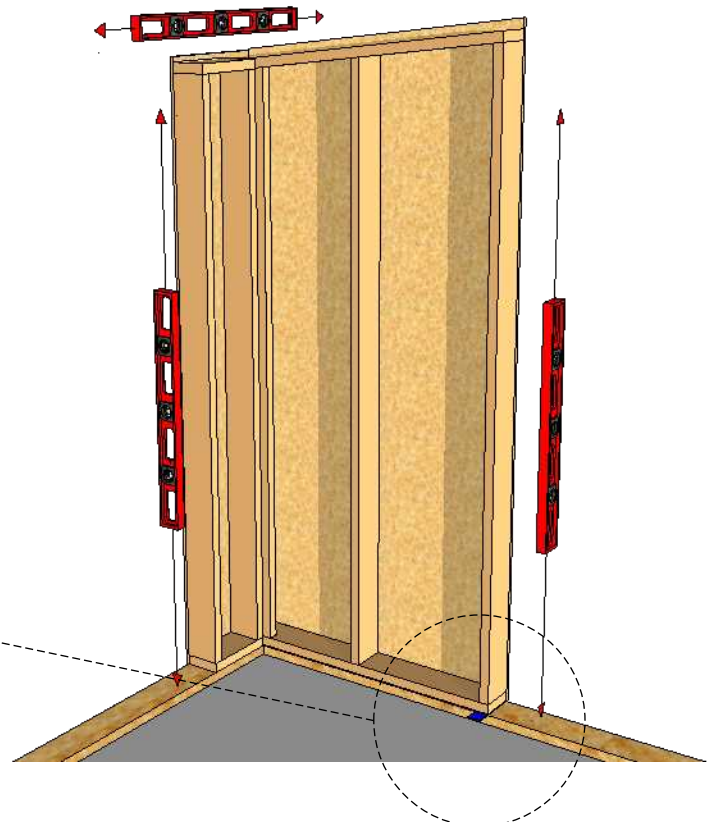
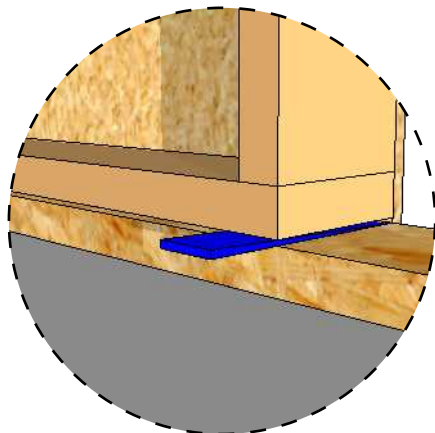

**STAND AND LOOSE FIT WALL PANELS (FASTENING):**

Fig 7a:

\*Different length wood screws will be used depending on the number of studs present at the connection:

If you are screwing **into one stud** use #12 x 3" wood screws.

If you are **screwing into 3+ or more studs** use #12 x 4" (Min.) wood screws.

**\*Be aware of where the screws are going to avoid damage to the shed (especially around windows!)\***

- Install a wood screw ~6" from the bottom, in the middle and ~6" from the top of the wall panel into the adjacent wall panel. Ensure panels are level, plumb and flush **every time**.

- Install a wood screw at each end of the wall panel into the sill plate to keep from moving or falling in windy conditions. Use bracing as needed.

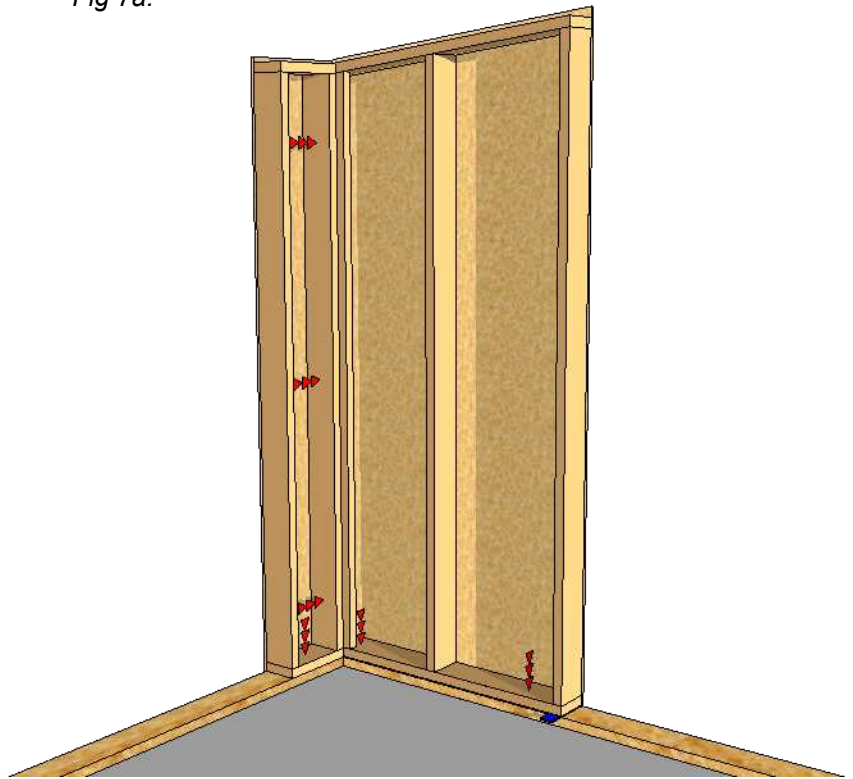

**STAND AND LOOSE FIT REMAINING BACK AND SIDEWALL PANELS:**

Fig 7b:

- Use methods in Fig 5a-7a

- In addition, to aid pulling panels into alignment, clamp top plates to top of wall panels and sheathing

**\*End of LVL top plates will be painted red. Color may vary (verify LVL material)\***

**\*Front and back top plates will overlap side walls\***

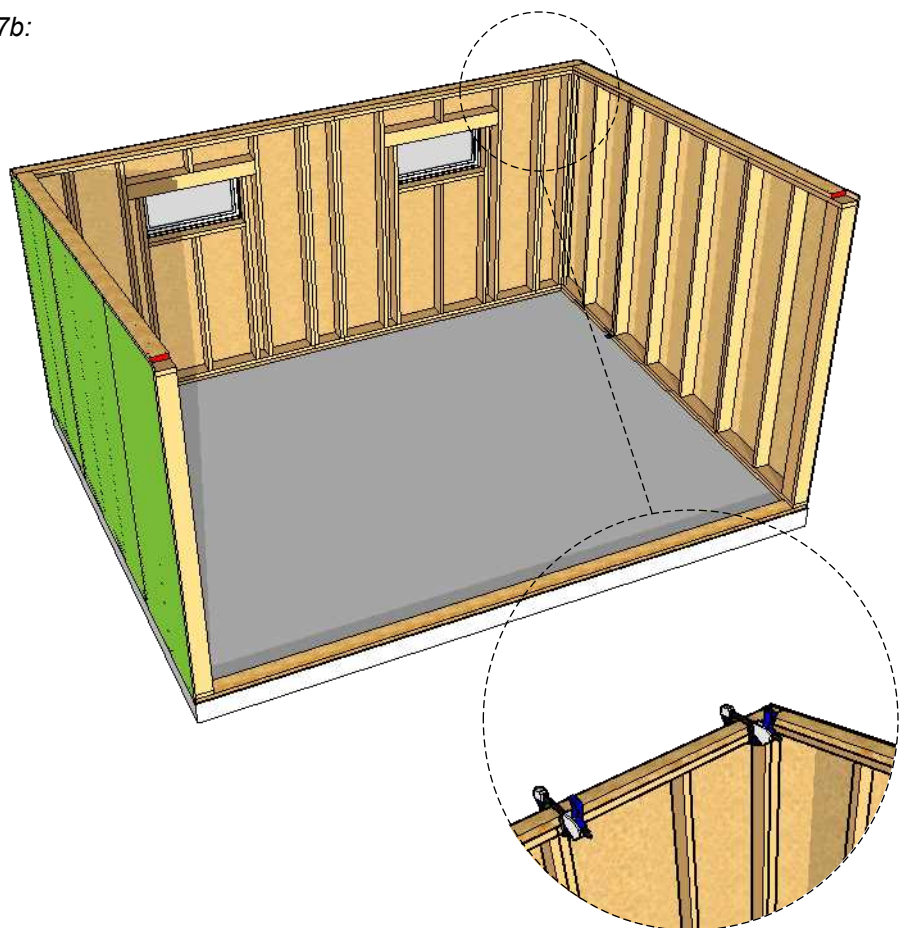

 Reference project installation drawings for top plate locations and lengths.



**STAND AND LOOSE-FIT FRONT WALL PANEL:**

Fig 8a:

- Use methods in Fig 5a-7a
- In addition, to aid pulling panels into alignment, clamp top plates to top of wall panels and sheathing

**\*End of LVL top plates will be painted red. Color may vary (verify LVL material)\***

**\*Front and back top plates will overlap side walls\***

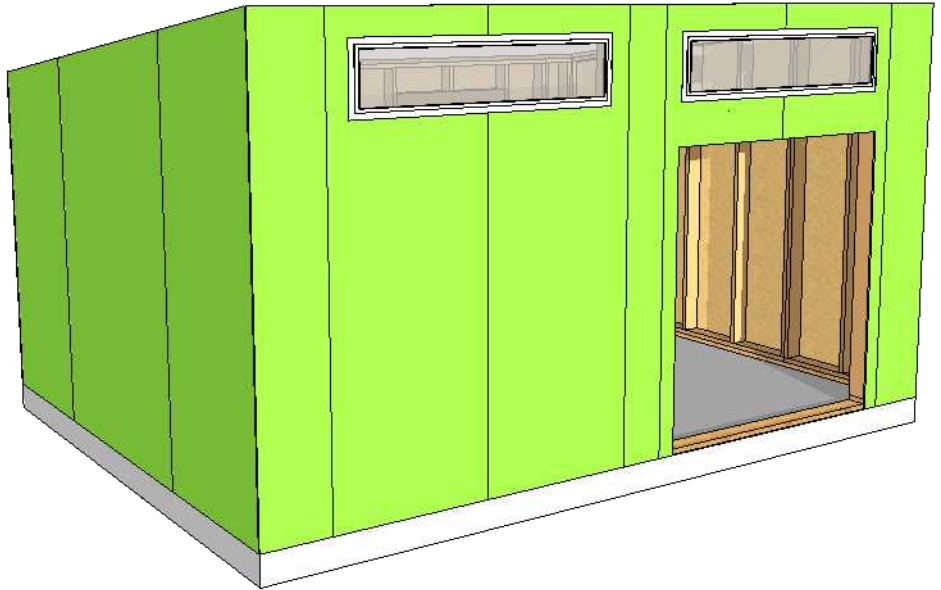

**SECURE TOP PLATES:**

Fig 8a:

- Use clamps to help facilitate connections
- Install four (4) 3" wood screws at the end of the top plates into the top of the wall panels, TYP all sides
- Install two (2) 3" screws on each side at wall panel intersections. TYP all sides
- Install 3" wood screws, 12" apart on center within wall panels. TYP all sides

**\*USE CAUTION USING SCREWS TO AVOID DAMAGE TO WINDOWS\***

**\*Top plate seams should overlap panel seams by 2' min whenever possible.**

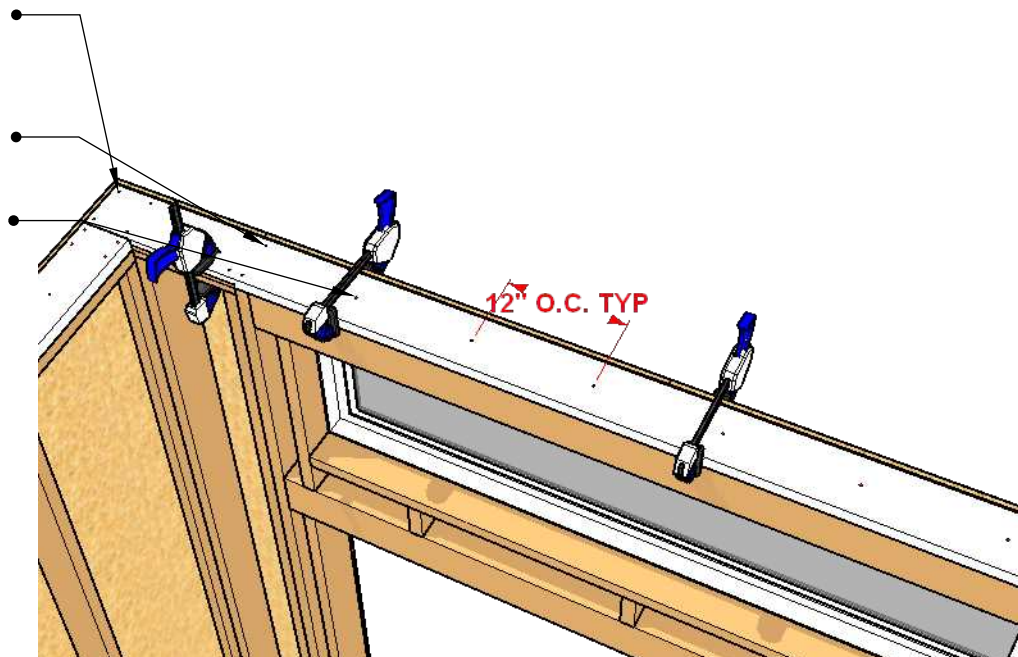

**▲ Reference permit plan set for additional details**

**FOR CONCRETE FLOOR:  
ANCHOR WALL PANELS TO CONCRETE  
SLAB:**

- Wall panels need a minimum of two (2) anchors starting with one (1) at each end. Additional anchors are needed if the spacing between the anchors exceeds 48"

- As close to wall panel ends as possible, within 6", drill through wall panel bottom plate and pressure treated sill plate using a power drill with 5/8" paddle bit

- Using rotary hammer drill with 1/2" Ø masonry bit, drill into the concrete floor 1/2" deeper than supplied bolts will be embedded

- Clean out hole using compressed air

**\*See instructions for Simpson titen bolts for more info**

**▲ Reference permit plan set wall schedule for applicable projects. If hold-downs are required, these count toward anchor spacing.**

Fig 9a:

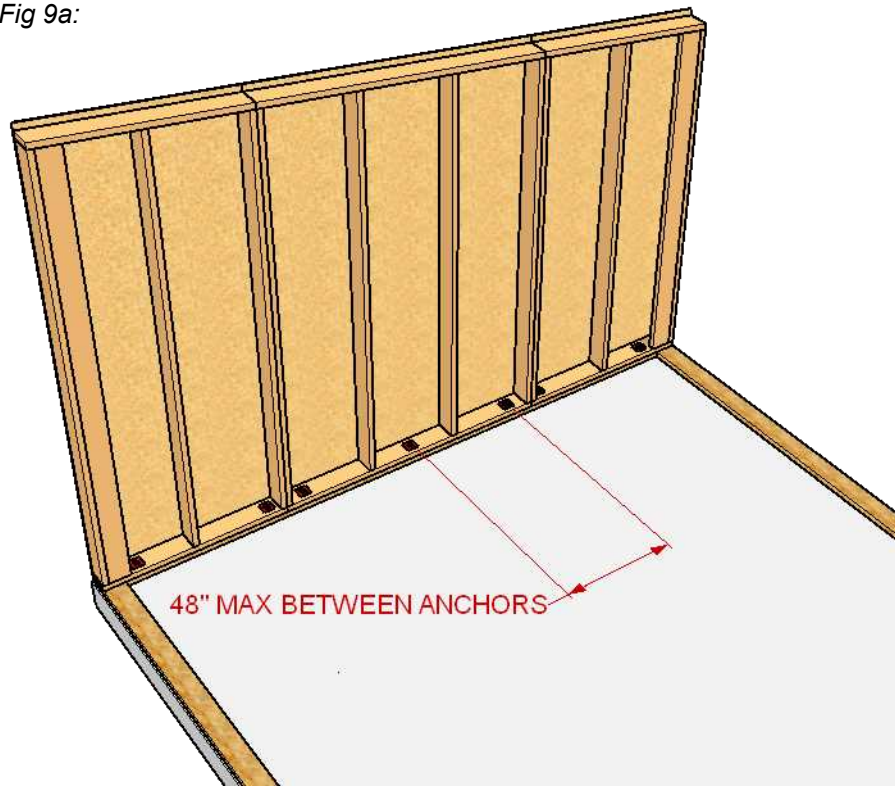

**FOR CONCRETE FLOOR:  
ANCHOR WALL PANELS TO CONCRETE  
SLAB:**

- At each hole install a Simpson strong-tie titen HD bolt and 3"x3" square plate washer

**\*FOR AREAS UNDER WINDOWS (AT VISTALITES), USE A PADDLE BIT TO DRILL A HOLE THROUGH WINDOW SILL TO CREATE A VERTICAL PATH FOR THE BOLT\***

**\*USE CAUTION AROUND WINDOWS\***

Fig 9b:

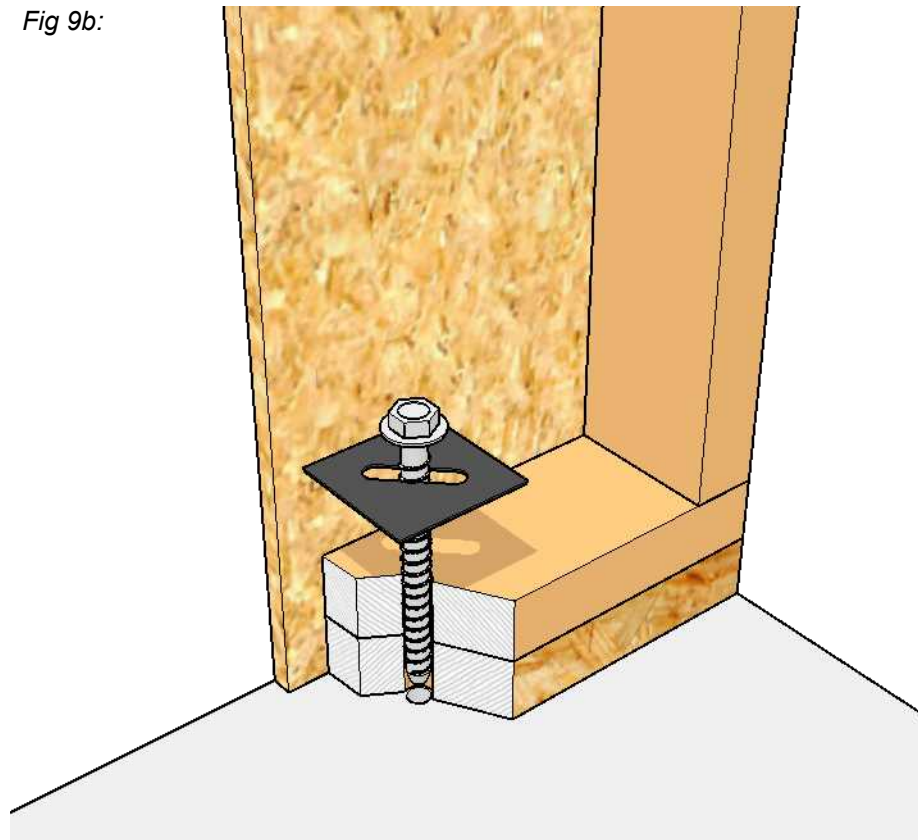

**INSTALL FINAL 3" SCREW AT ALL WALL PANEL CONNECTIONS:**

- Using a T25 torxbit, install 3" wood screws 12" apart on center to connect adjacent panels. Start at bottom of panels and work toward top.

- Initial tack screws can be included in 12" on center spacing

\*Different length wood screws will be used depending on the number of studs present at the connection:

If you are screwing into 2 studs use #12 x 3" wood screws.

If you are screwing into 3 or more studs use #12 x 4" (min) wood screws.

Fig 10a:

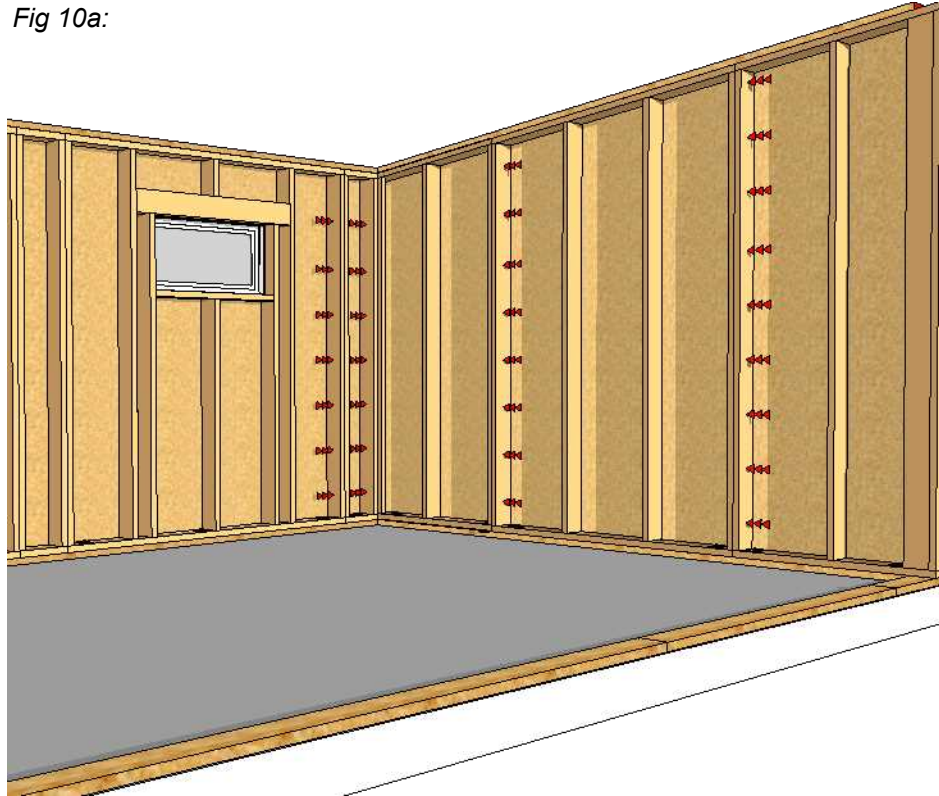

**NAIL WALL SHEATHING INTO TOP PLATE, SILL PLATE AND CORNERS:**

- At ~3/4" down from the top of the wall sheathing, install 2 3/8" ring shank nails 6" on center through wall sheathing into top plate

- At ~3/4" up from the bottom of wall sheathing, install 2 3/8" ring shank nails 6" on center through wall sheathing into sill plate

- At ~2" from side walls install 2 3/8" ring shank nails 6" on center vertically through wall sheathing into studs at front and back

**\*A PNEUMATIC FRAMING NAILER IS RECOMMENDED\***

Fig 10b:

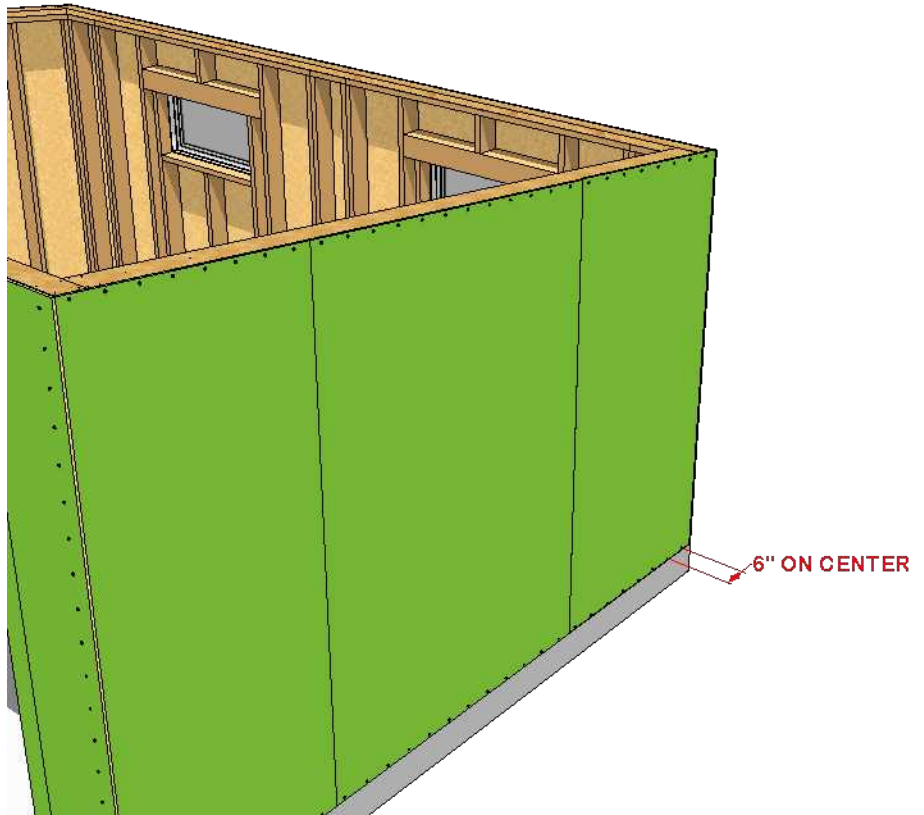

 **Reference permit plan set wall schedule for required nail spacing (Shear Nail Inspection)**

**WEATHERSEAL THE SHED:**

- Use the supplied ZIP System sheathing tape

**\*We recommend using a Huber ZIP system tape roller for warranty to cover application\***

For concrete foundations:

- Caulk seam at base with provided silicone  
 - Tape all vertical wall panel intersection seams (overlap equally)

**\*Use a roller\***

- Cover any exposed screw holes and small damaged sections with tape

- Tape the seams between the top of the wall panels and the top plates by wrapping the tape over the top of the walls (overlap the tape equally)

*Fig 11a:*



**CUT SILL PLATE AT DOOR OPENING:**

- Cut sill plate flush with studs at either side of door opening.

*Fig 11b:*

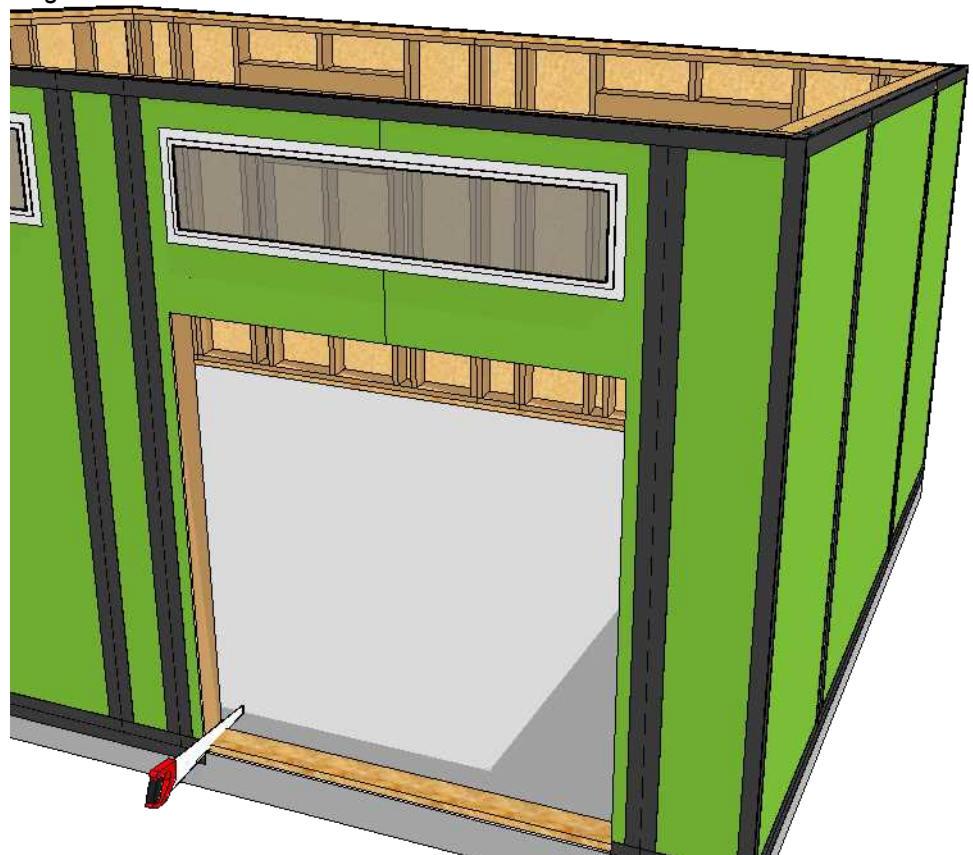

**START RAFTERS:**

Fig 12a:

- Lift and place rafters.
- Position the rafters 1'-11 1/8" from the face of the side wall exterior sheathing
- \*For 2x10 Fir rafters, position the rafter 1'-11 1/4" from the face of the side wall exterior sheathing\***
- Position the rafters 1'-10 1/2" from the face of the front wall exterior sheathing

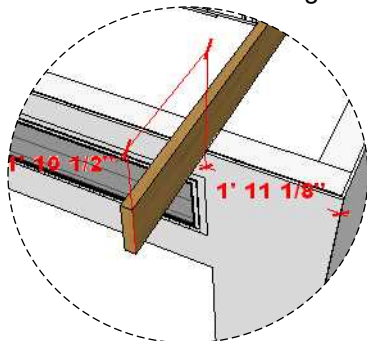
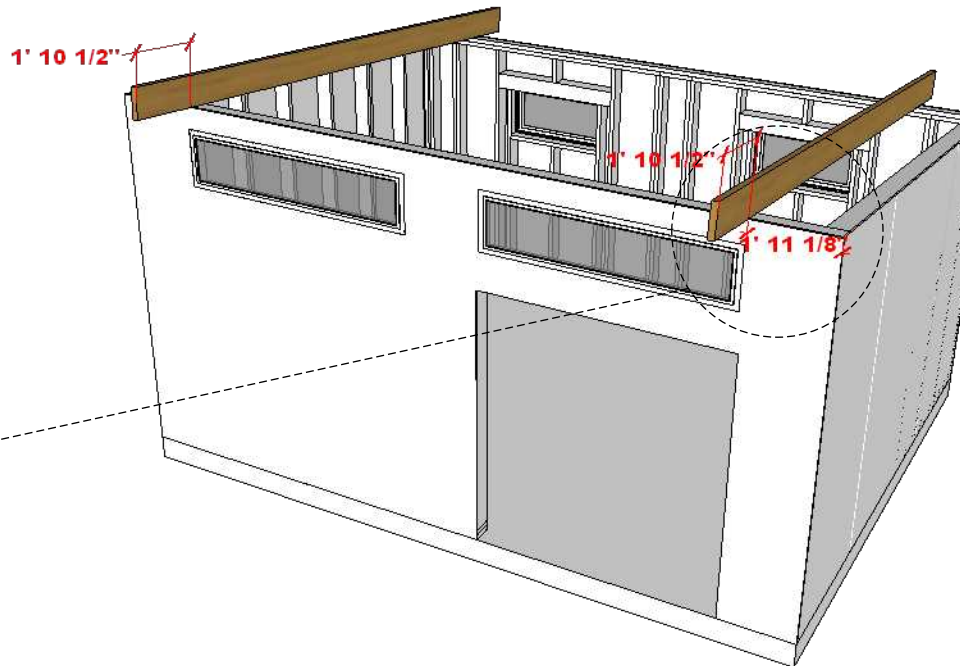

 Reference project installation drawings for rafter assembly

**INSTALL INTERMEDIATE RAFFERS AND BLOCKING:**

Fig 12b:

- On center spacing between the rafters should be equal (roughly ~2')
- Use the supplied blocking 'D' material
- \*Blocking may not have venting notch**
- Toe screw rafters using 3" screws. Be aware of where screws are going to ensure they do not poke through framing

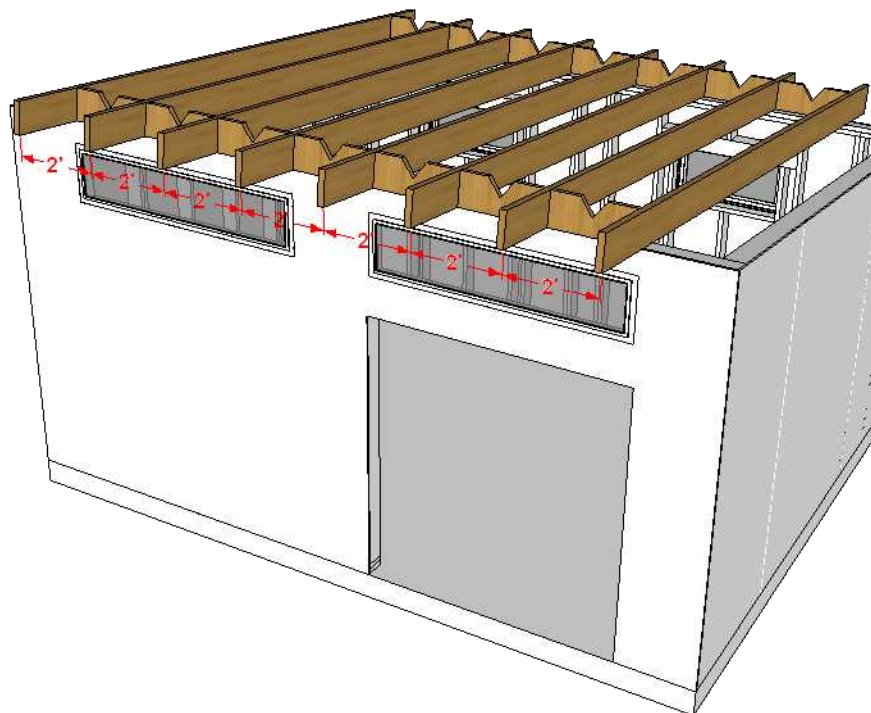

 Reference project installation drawings

**INSTALL OUTRIGGERS AND BLOCKING:**

Fig 13a:

- (1) Lift into place 'C' blocking
- (2) Lift into place the pre-cut rafter blocking (typ. 'D' and 'F' blocking)
  - Align face of pre-cut rafter blocking to be flush with outside face of rake wall sheathing
- (3) Lift into place outriggers
  - \*Outriggers must be flush with top plate and bottom of rafters\***
    - For vented assembly, outriggers will not be flush with top of rafters.
- (4) Lift into place the intermediate blocking (typ. 'E' blocking)
  - Nail outrigger to each rafter with three (3) 16d x 3 1/2" galvanized nails.

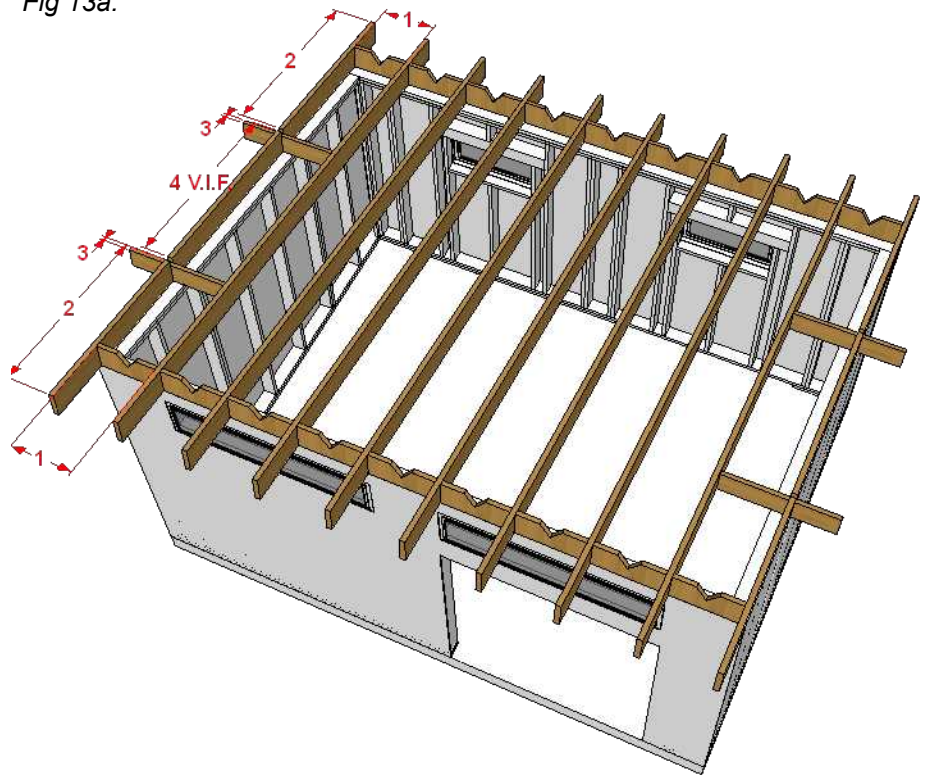

 Reference project installation drawings

**SUB-FASCIA:**

Fig 13b:

- Install front and back sub-fascia boards.
- \*Depending on size of rafters, will either be 2x10 or 2x12 sub-fascia boards**
- \*Depending on roof configuration, the fascia boards will overhang sides by 6" or 16"**
- Nail sub-fascia board to each rafter with three (4) 10d x 3" galvanized nails. Center butt joints, where sub-fascia boards meet, on a rafter

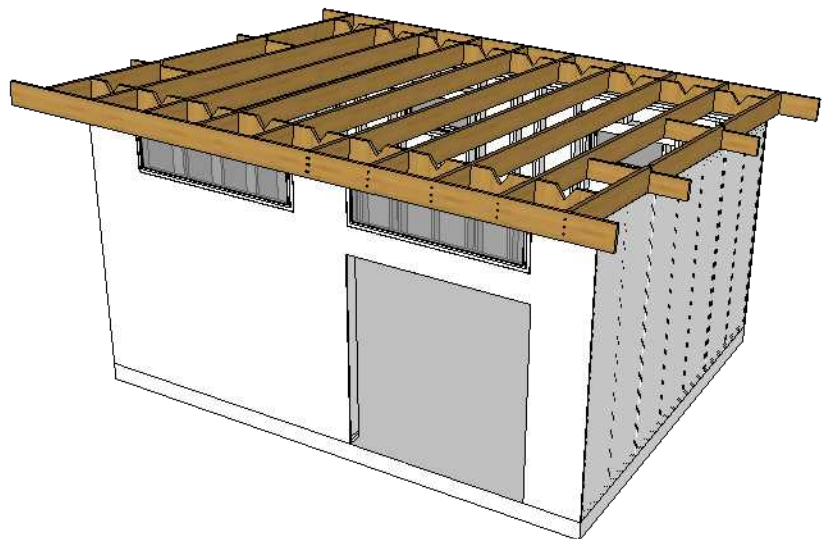

 Reference project installation drawings

**OUTER RAFTERS:**

- Install outside LVL rafters on each side
- Nail to outriggers with three (3) 16d x 3 1/2" galvanized nails.
- Nail to sub-fascia boards with three (3) 16d x 3 1/2" galvanized nails.

*Fig 14a:*

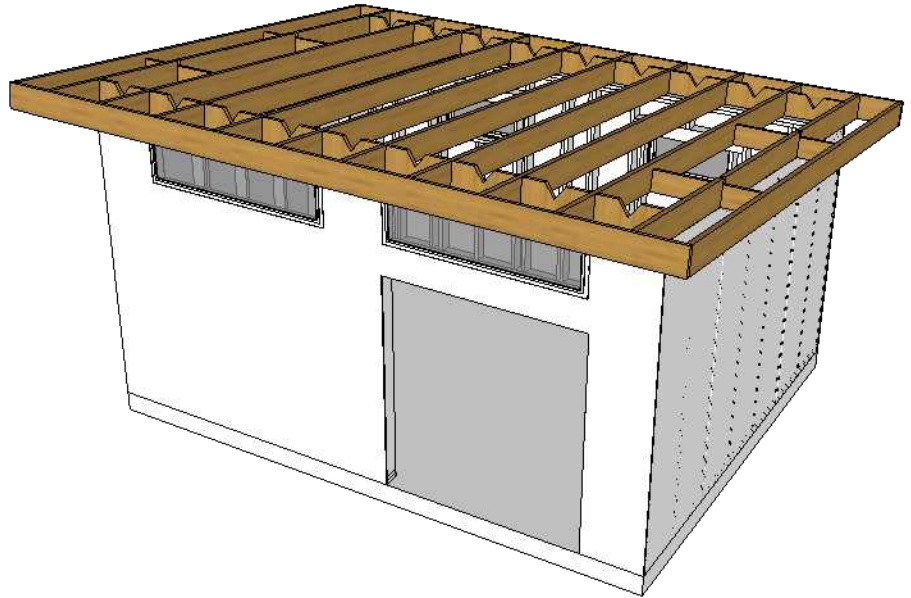

**CHECK ROOF ASSEMBLY FOR SQUARE!!**

- Use a tape measure to check for square by measuring from opposite inside corners of the sill plate reference lines
- The measurements should be equal
- If unequal, make ay adjustments to make sure edge distance and squareness are correct.

**INSTALL 6" RAFTER TIE SCREWS AT ALL LOCATIONS WHERE RAFTER OR OUTRIGGER IS PERPENDICULAR TO TOP PLATE:**

- Use the provided metal guide to install the Timberlok screw at the optimal angle of 22.5 degrees @ center of rafter
- Follow Simpson install video for installation without a guide

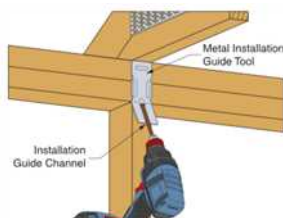

*Fig 14b:*

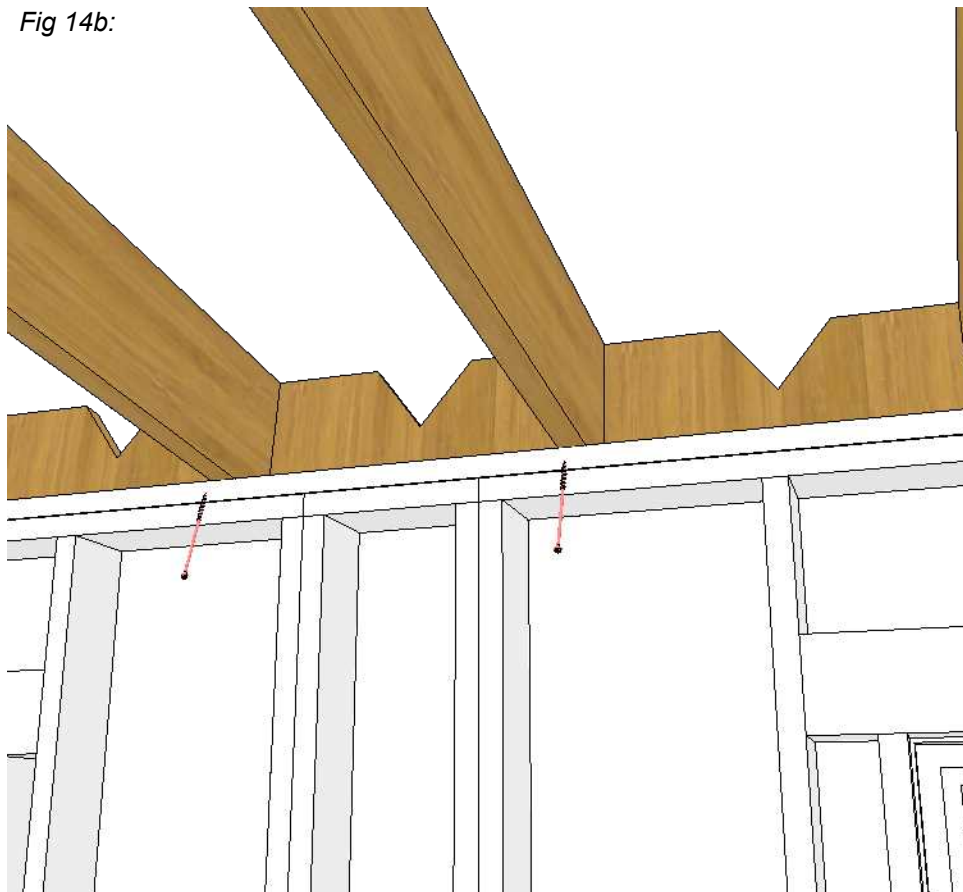

**SECURING ROOF ASSEMBLY:**

*Fig 15a:*

- Toe nail blocking members into rafters and outriggers
- Install A23 brackets at designated locations using 10d x 1 1/2" nails
- For rafter to sub-fascia connections and blocking to outrigger connections, mount bracket vertically centered on rafter.

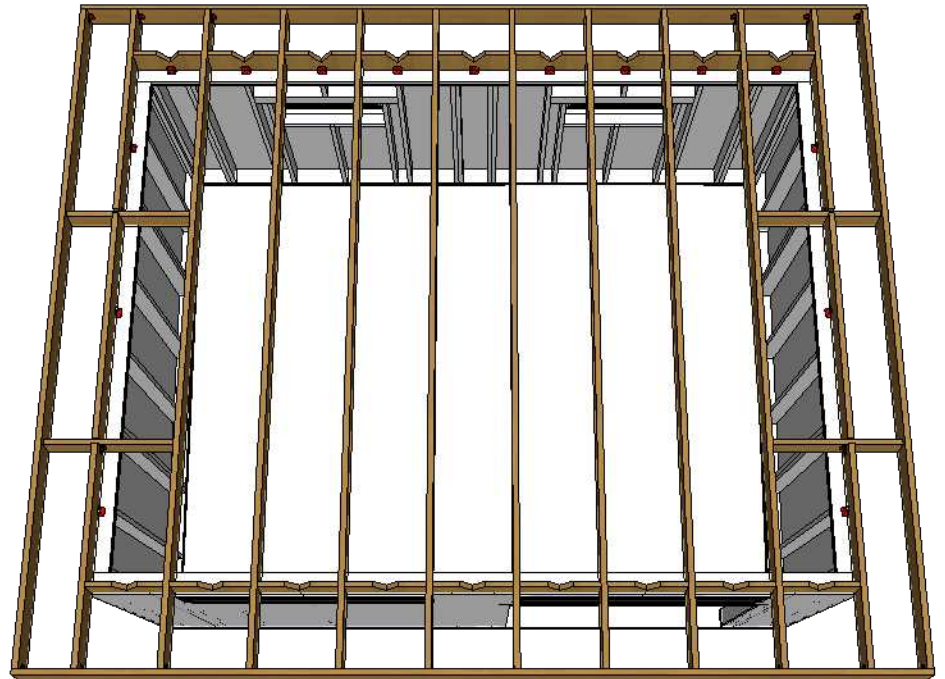

 Reference project installation drawings

**SOFFIT NAILERS:**

*Fig 15b:*

- 2x4 soffit nailers shown in red for clarity
- \*BEWARE OF WHERE NAILS ARE GOING TO AVOID DAMAGE TO THE BUILDING\***
- Start installing nailers 2'-0" on center from outriggers
- Toe nail 2x4 nailers with two (2) 10d x 3" framing nails at each side

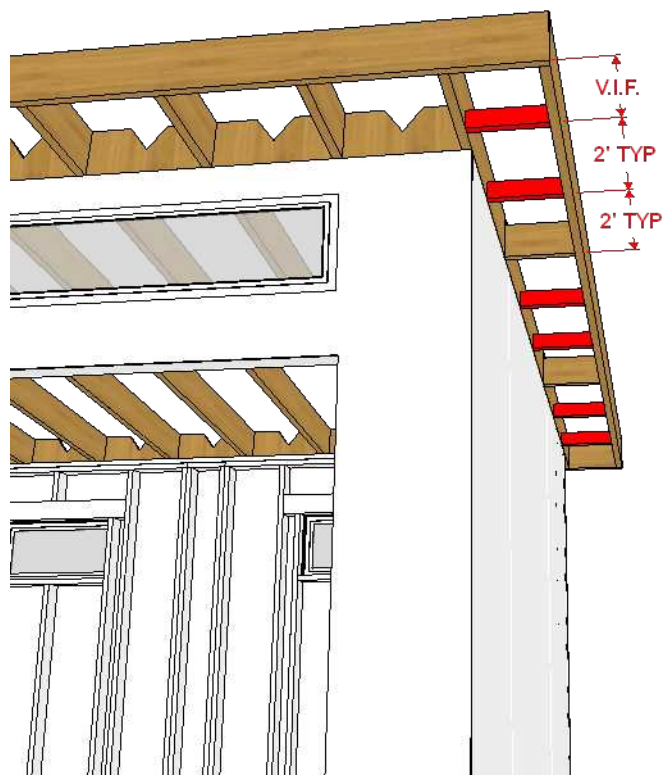

 Reference project installation drawings



**SECURE ROOF SHEATHING:**

*Fig 16a:*

- Roof sheathing provided in CDX.
  - Start along short edge, in the order shown, to maintain leverage when aligning the sub-fascia to the edge of the sheathing.
  - Sheathing should be fastened with 8d ring shank nails
- \*Secure with minimal fasteners in case of minor adjustments\***

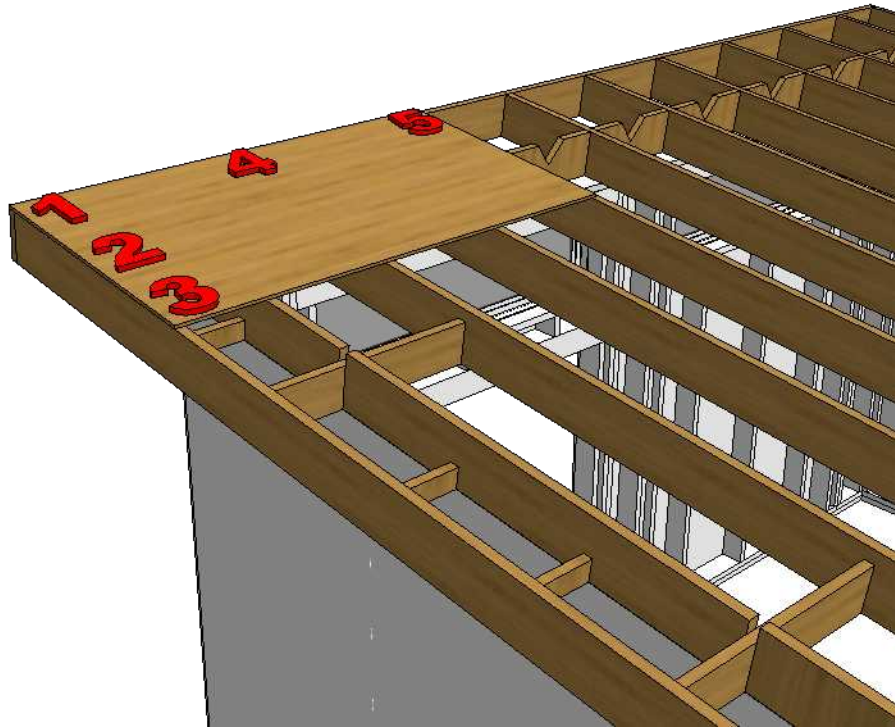

*Fig 16b:*

- Snap chalk lines centered on all framing members for nailing lines.
- Nail sheathing to rafters using 8d ring shank nails 6" on center at blocking, edges of sheets, and over eaves, as shown.
- Then nail 12" on center in the field of each panel. Be aware of where nails are going to ensure nails do not poke through framing

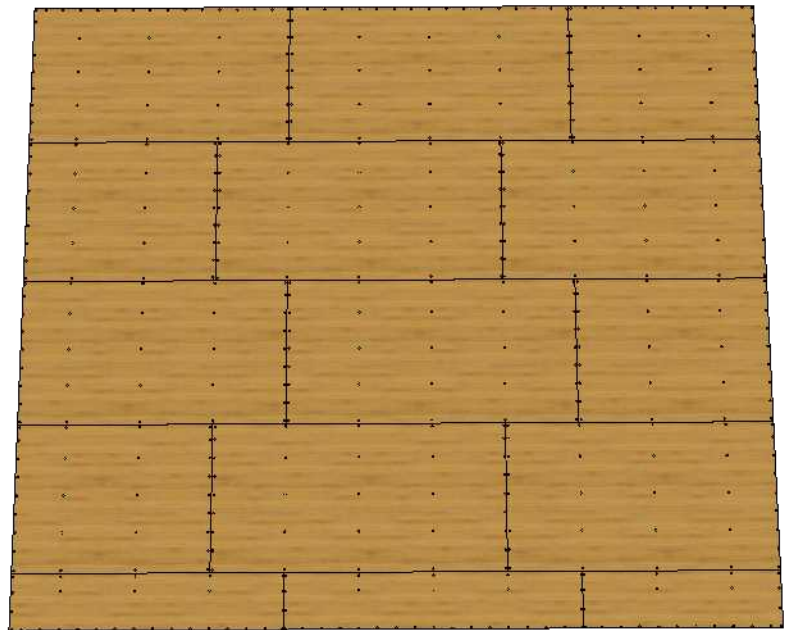

**INSTALL RAKE SOFFIT:**

- Ensure soffit panels are square prior to nailing it to the roof

**\*Rake walls - align soffit from outside edge of floating rafter\***

- Start at front and work towards back
- Nail 4d nails at 8" on center.

**\*Do not install nails closer than 2" from panel corners and 3/8" in from panel edges\***

- Caulk all seams with an exterior rated paintable caulk and touch-up paint as required

Fig 17a:

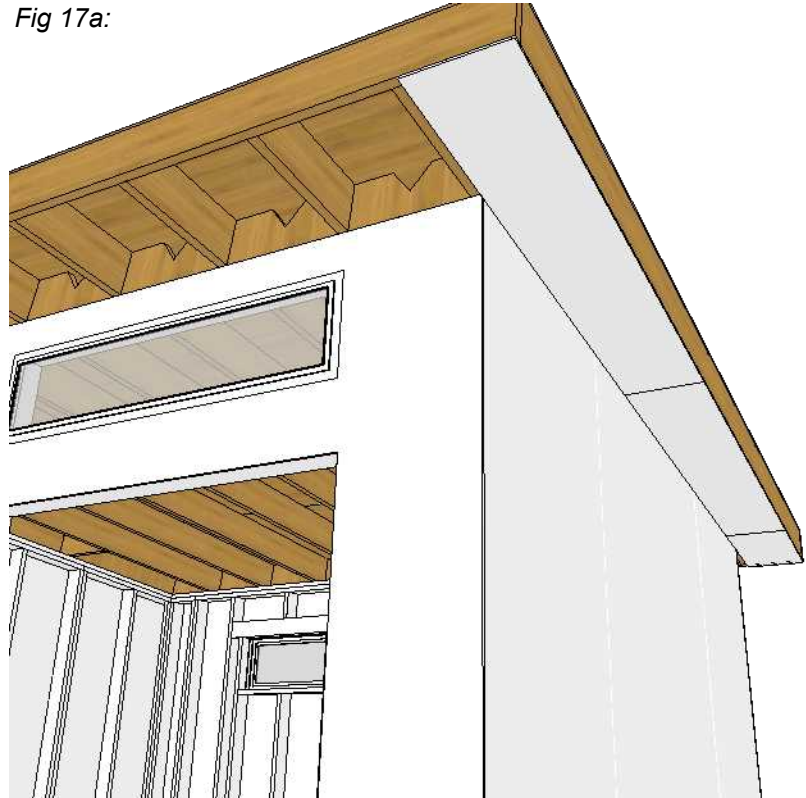

 Reference project installation drawings

**INSTALL SOFFIT:**

Fig 17b:

**\*Front and Back - align soffit starting from outside edge of sub-fascia\***

- Repeat instructions from 17a

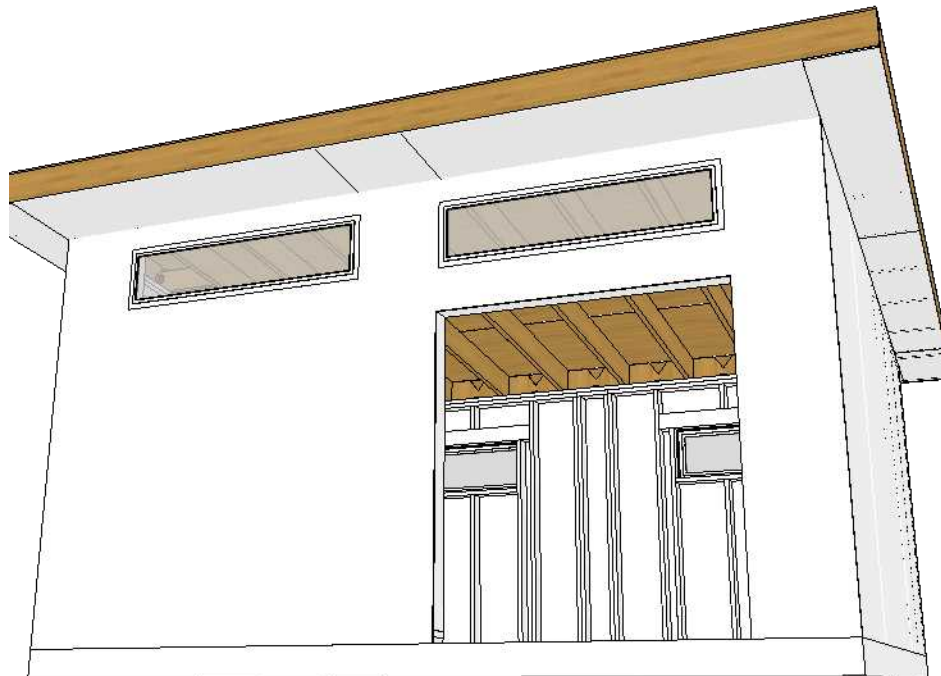

 Reference project installation drawings

**INSTALL METAL PROFILE 'S' (FASCIA DRIP EDGE):**

- Measure and plan cuts for corner pieces.
- Wrap corner by cutting drip flange, then bending the vertical face 90°
- Start at an inconspicuous corner, align angle in drip flange with lowest edge of soffit or venting profile.
- Use a pneumatic stapler to staple the long leg of venting detail to outer face of sub-fascia board
- Cut other 'S' profile to fit
- Overlap corner pieces by ~3" and staple at overlaps

*Fig 18a:*

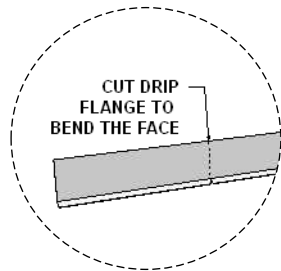
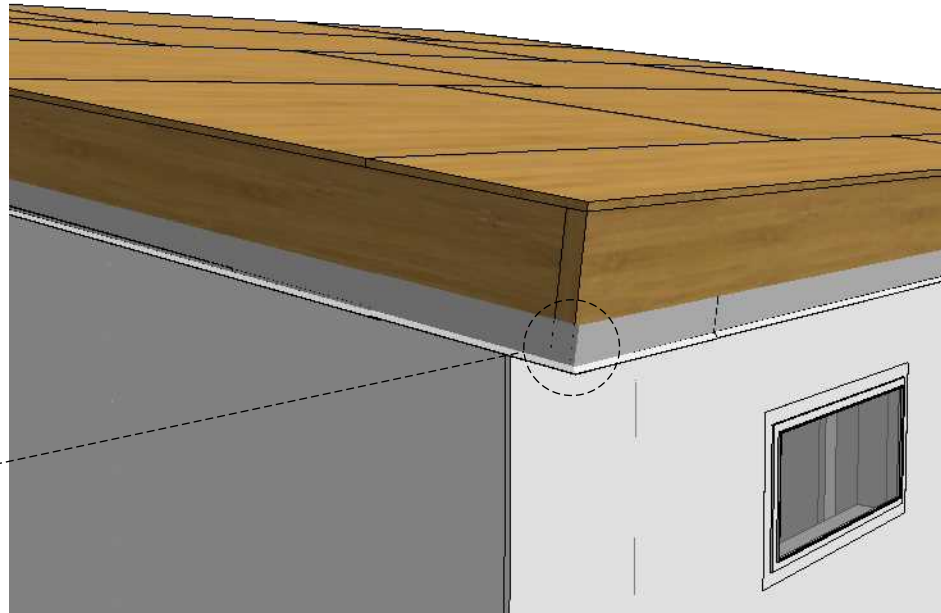

**INSTALL HARDIE FASCIA:**

- Start at a back corner and work your way to the opposite side to create the first row.
- Review the Hardie Lap siding guide for more info

*Fig 18b:*

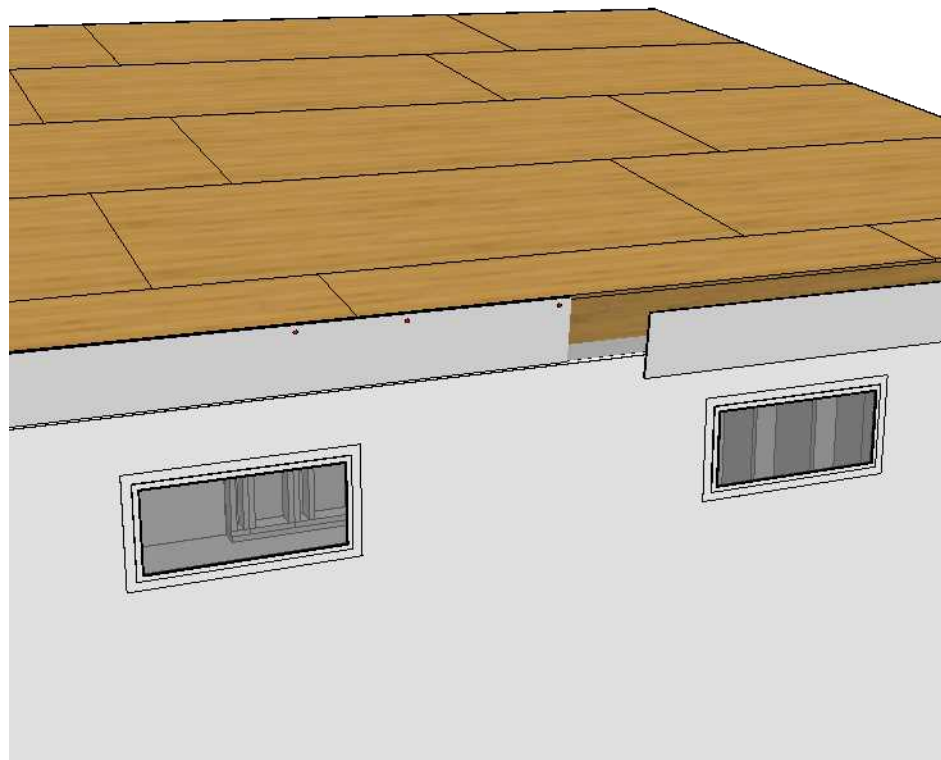

**STOP!**

**PLEASE CONFIRM WHICH ROOF PACKAGE YOU HAVE!**

**IF R-5 RIGID FOAM INSULATION IS REQUIRED, PLEASE REFER TO THE RIGID FOAM ROOF INSTALLATION GUIDE TO FINISH YOUR SHED**

**IF IT'S OUR STANDARD PRODUCT, PLEASE CONTINUE READING BELOW**

 **Reference permit plan set for applicable projects.**

**Install metal profile 'J' (back roof drip edge):**

- Place one piece of drip edge on top of the roof sheathing.
- The short length will be on top
- Use a pneumatic stapler to staple the top of drip edge to the roof sheathing.
- Space staples 6" - 12" on center
- Add additional pieces as needed

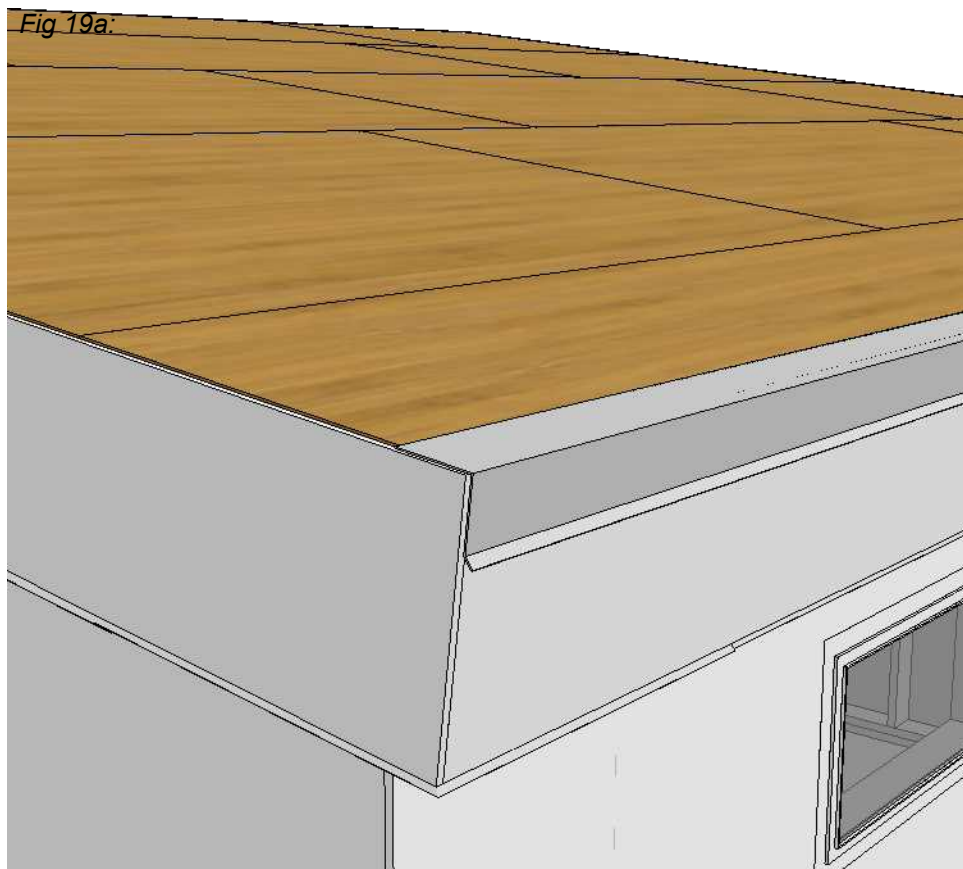

**INSTALL ROOFING FELT:**

*Fig 20a:*

- Start at the low side of the shed and work toward the front
- Overlap each row 6" over the top of the lower row
- Use plastic cap nails or staples to hold felt in place
- Working low to high will ensure proper drainage once the roof is installed

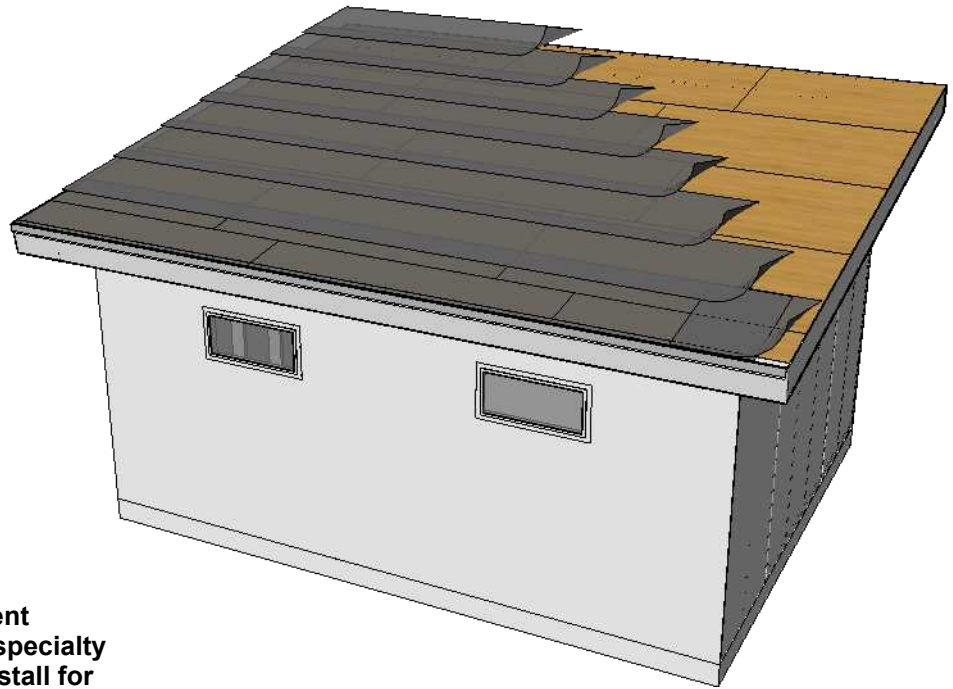

**▲ Reference permit plan set for underlayment specs. Certain jurisdictions may require specialty underlayment. Consult manufacturer's install for other types**

**INSTALL CORRUGATED METAL ROOFING:**

*Fig 20b:*

- Start at a back corner overhanging Hardie fascia by 1/2" and work your way to the opposite side to create the first row. Overlap corresponding panels two peaks
- Using an impact driver and the provided #10 x 1 1/2" neoprene washer screws, install (1) screw 1 1/2" from back edge, then install (1) screw every 4 valleys (~12") along the back edge. Be sure to install screws in the valleys where panels overlap

**\*Do not grid with fasteners at this time**

- Add the next row by following the methods above, aligning metal to the front edge. install one row of screws into the front edge. each row must overlap previous rows by at least 6"

**\*Do not use any fasteners other than the roof screws with neoprene washers provided by Studio Shed**

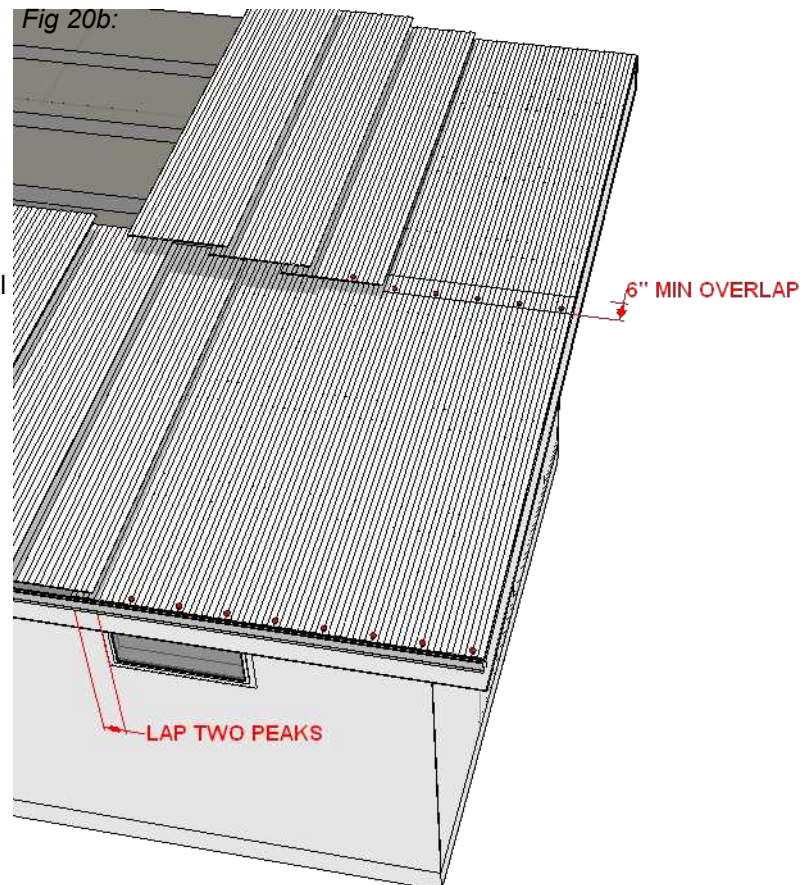

**Once all panels are in place:**

- Install rows of #10 x 1 1/2" neoprene washer screws 30" on center.
- Measure from the back row of fasteners installed earlier, reference Fig 20b
- Follow the same pattern as previously described
- Use a chalk line to ensure straight rows

**\*Tighten up spacing to 24" on center in areas where the ultimate design wind speed, VULT, exceeds 110 mph**

- Screws in green have already been installed

Fig 21a:

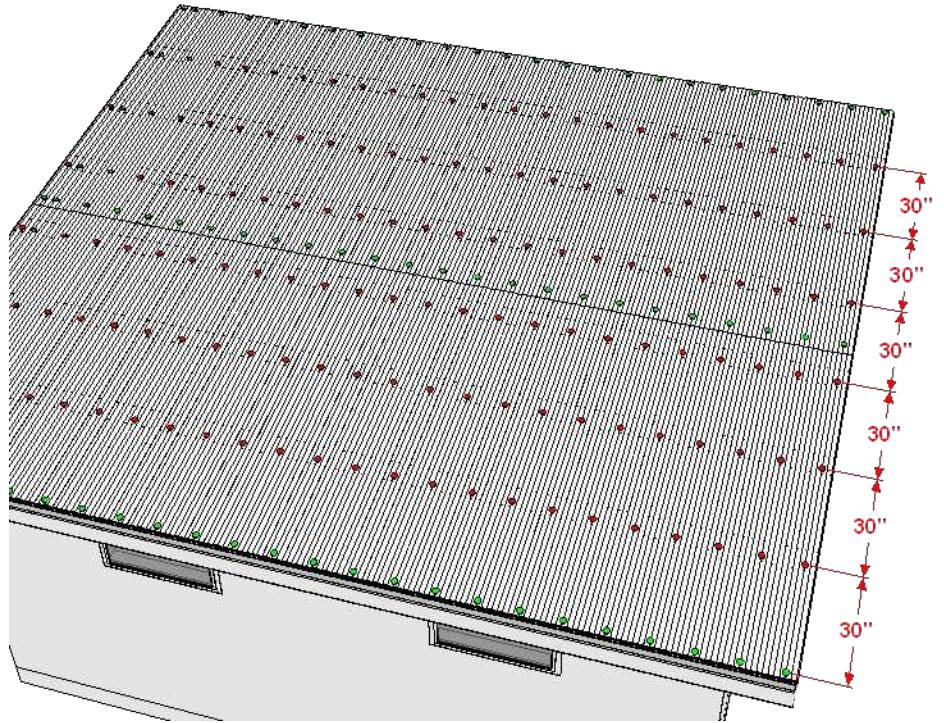

 **Reference permit plan set for applicable projects. Local building codes may require tighter spacing**

Fig 21b:

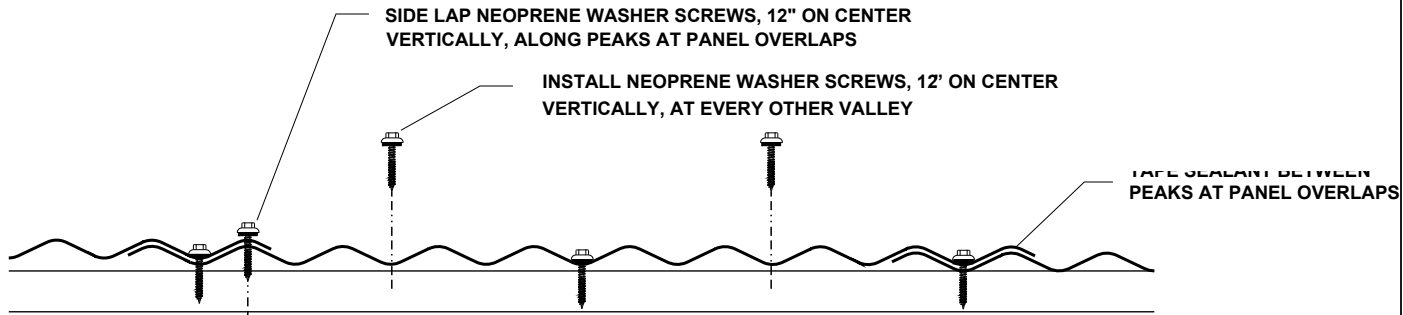

Fig 21c:

**\*DO NOT OVERTIGHTEN SCREWS!**



- Install #10 x 1 1/2 neoprene washer screws at every other valley

Fig 22a:

- Screws in green have already been installed

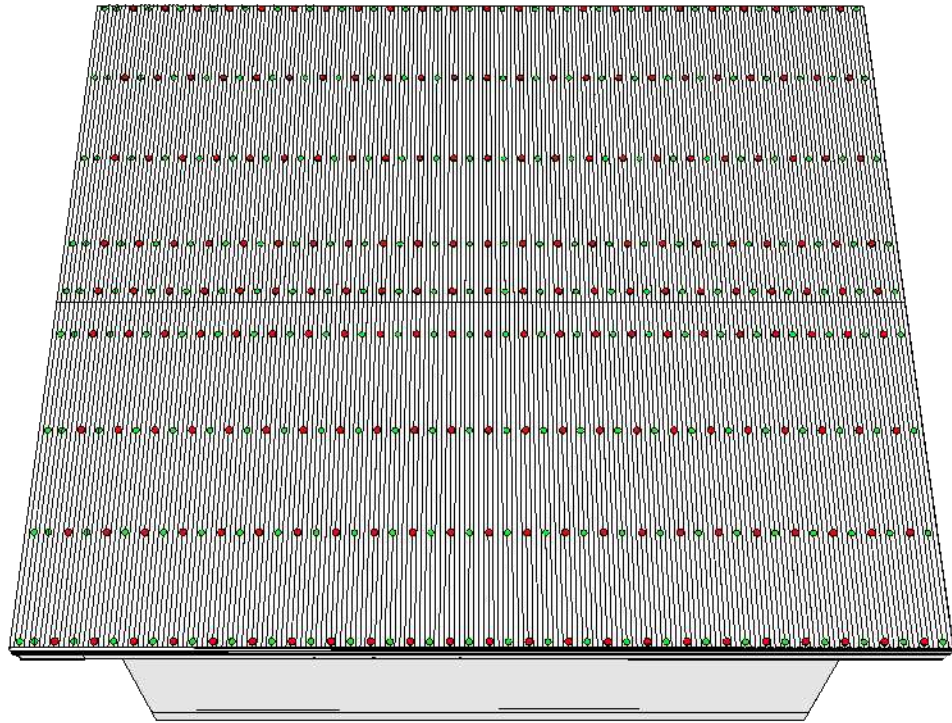

Fig 22b:

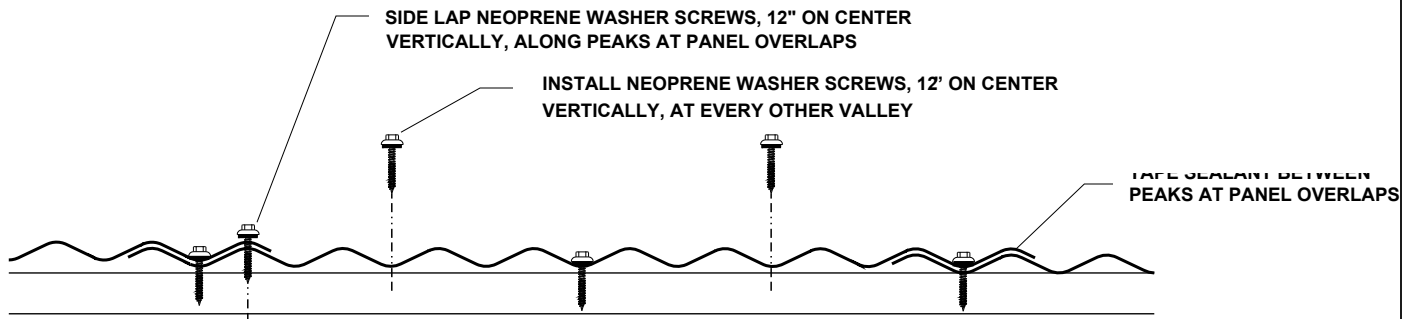
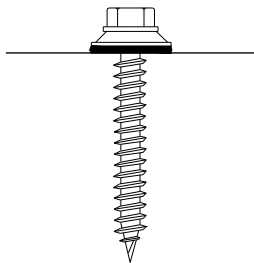

Fig 22c:

\*DO NOT OVERTIGHTEN SCREWS!

**CORRECT**



SEALING MATERIAL SLIGHTLY VISIBLE AT EDGE OF WASHER. ASSEMBLY IS WATER TIGHT.

**TOO LOOSE!**

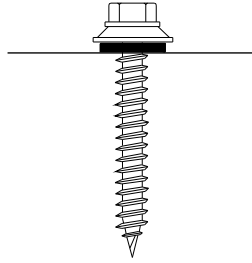

SEALING MATERIAL IS NOT VISIBLE; NOT ENOUGH COMPRESSION TO SEAL.

**TOO TIGHT!**

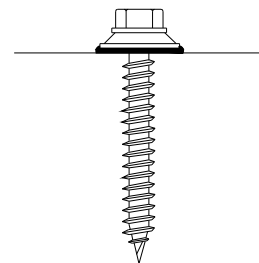

WASHER IS DEFORMED; SEALING MATERIAL PRESSED BEYOND FASTENER EDGE.

**INSTALL THE METAL PROFILE 'A' (ROOF DRIP EDGE) ALONG SIDES AND FRONT OF SHED:** *Fig 23a:*

- Install 'A' profile with factory edge aligned at back with ends of roof metal. Use #10 x 1 1/2" screws to stitch top flange of profile to ridge of roof metal at low side, then again at ~24" from high side

**\*Do not install screws within 3" of front end**

**\*Do not overtighten screws!**

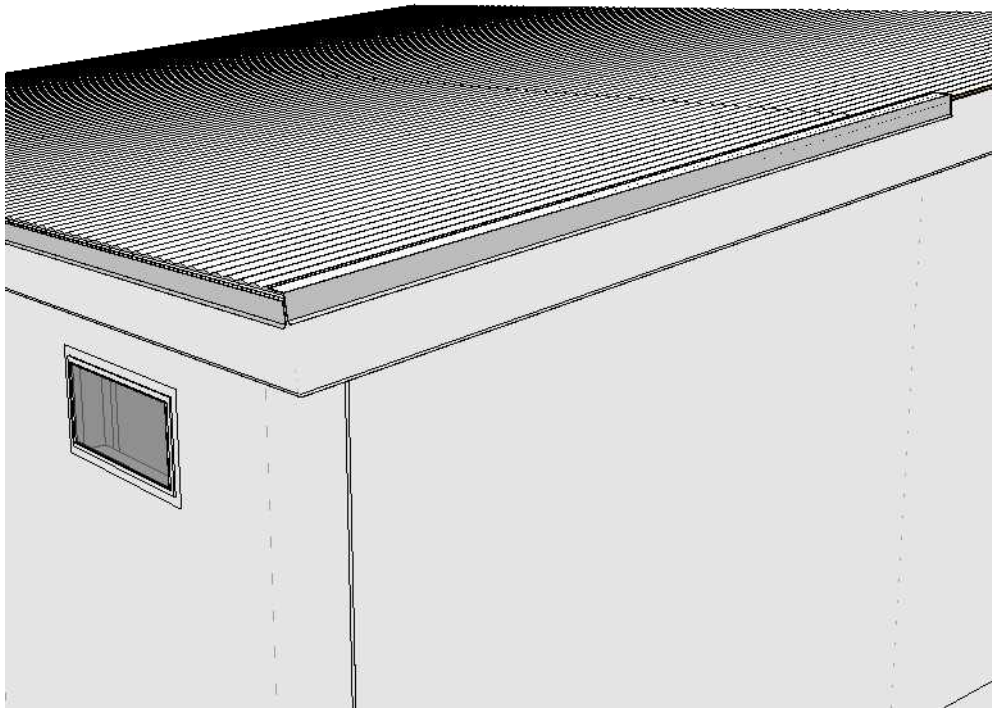

- Measure and plan cuts for corner pieces. Side legs should overlap existing piece by ~3" *Fig 23b:*

- Wrap corner by cutting the top flange and drip flange, then bend the vertical face 90°

- Install screw at overlap of existing 'A' profile. Pull front leg on front tight to the corner, then place a screw about 6" from the end of the front leg into a ridge of the metal below

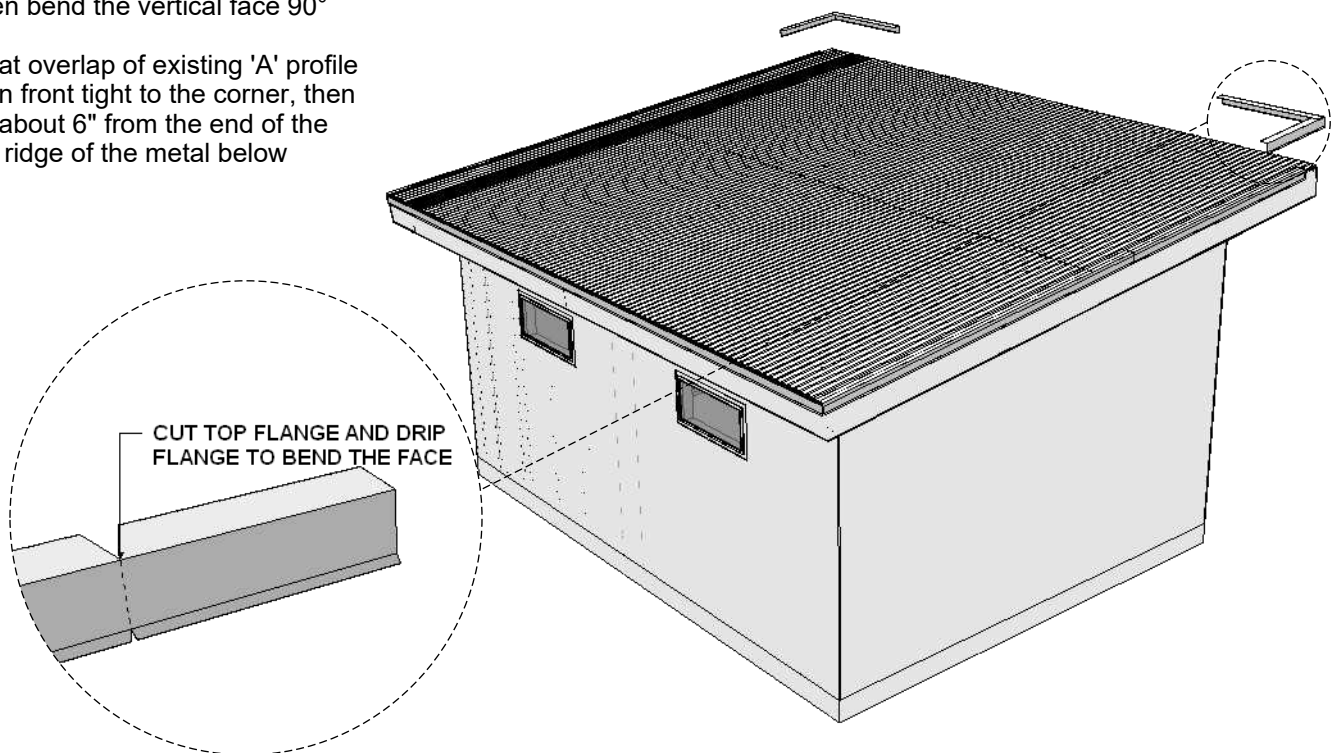



- Add roofing screws at the 'A' profiles into ridges of the roof metal at 18" on center

*Fig 24a:*

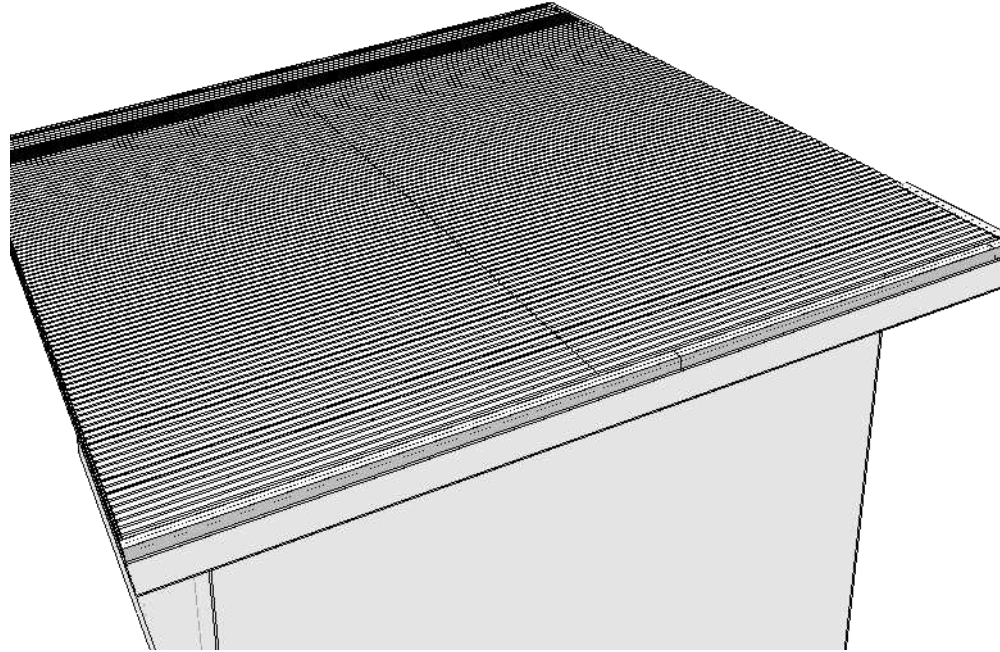

- Place final 'A' profile(s) on front. Install screws into ridges of roof metal at overlaps.

*Fig 24b:*

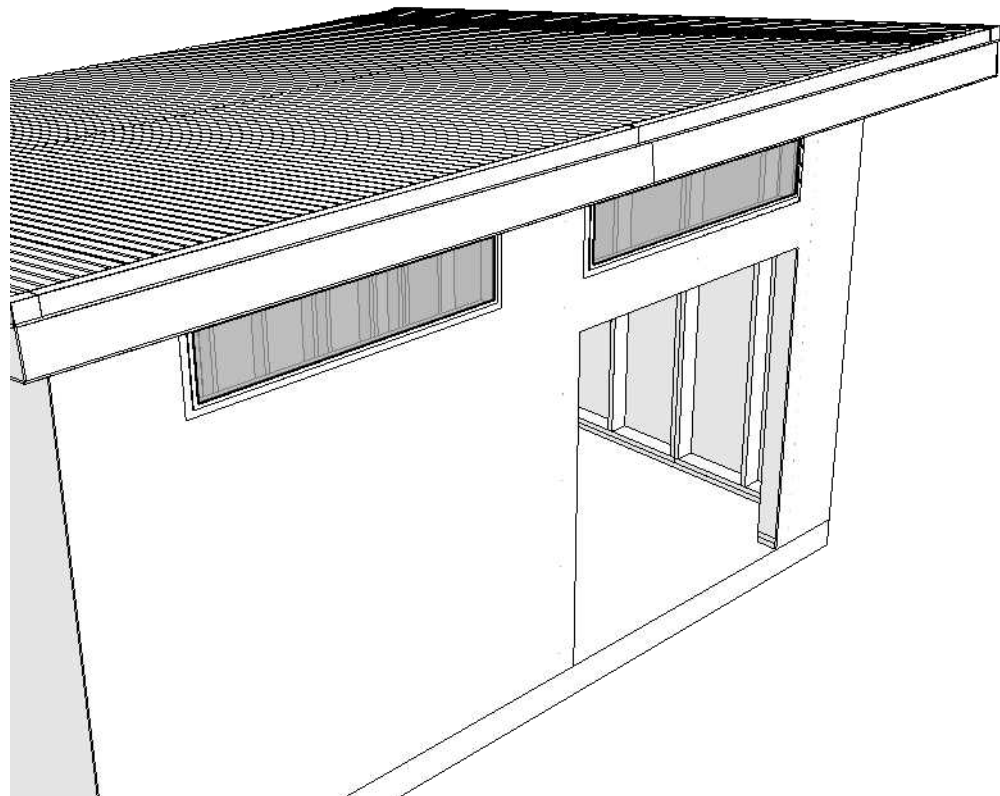

**\*FOR NEXT STEPS SEE TRIM AND SIDING INSTALLATION RESOURCES.**

**INSTALL DOOR PAN (PROFILE "K"):**

- Adhere pan to the base of shed by applying four generous beads of silicone lengthwise along metal the metal. The short leg will be vertical.

**INSTALL DOOR:**

- Follow door manufacturer's instructions for installation.

